

AUTODOME IP starlight 5000i

NDP-5512-Z30 | NDP-5512-Z30C | NDA-55A2-Z30CY

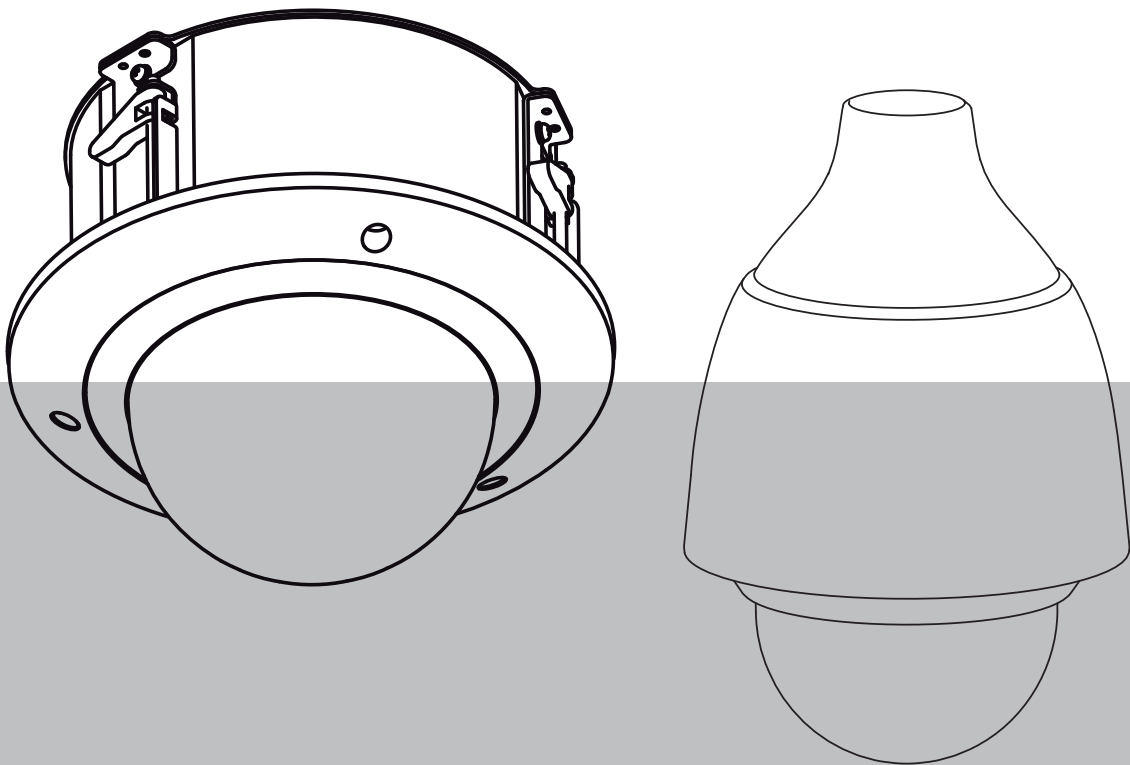

Table of contents

1	Introduction	6
1.1	System requirements	7
1.2	Establishing the connection	7
1.3	Establishing the connection	8
1.4	Establishing the connection	8
1.5	Configuration with Project Assistant app	8
1.6	Password protection in camera	9
2	System overview	10
2.1	Live page	10
2.2	Playback	11
2.3	Configuration	11
2.4	Dashboard	11
3	General	12
3.1	Identification	12
3.2	User Management	12
3.3	Date/Time	13
4	Web Interface	15
4.1	Appearance	15
4.2	'Live' functions	16
5	Camera	17
5.1	Installer Menu	17
5.1.1	Display Stamping	18
5.1.2	Positioning	22
5.2	Encoder Profile	23
5.3	Encoder Streams	25
5.4	Encoder Statistics	26
5.5	Lens Settings	26
5.6	PTZ Settings	26
5.7	Pre-positions and Tours	28
5.8	Sectors	29
5.9	Miscellaneous	29
5.10	Audio	29
5.11	Pixel Counter	30
6	Recording	31
6.1	Introduction to recording	31
6.2	Storage Management	31
6.2.1	Device manager	31
6.2.2	Recording media	31
6.2.3	Activating and configuring storage media	32
6.2.4	Formatting storage media	32
6.2.5	Deactivating storage media	32
6.3	Recording Profiles	32
6.4	Maximum Retention Time	34
6.5	Recording Scheduler	34
6.6	Recording Status	35
6.7	Recording Statistics	35
6.8	Image Posting	35
7	Alarm	37

7.1	Alarm Connections	37
7.2	Video Content Analysis (VCA)	38
7.3	Audio Alarm	41
7.4	Alarm E-Mail	41
7.5	Alarm Inputs	43
7.6	Alarm Outputs	43
7.7	Alarm Task Editor	44
7.8	Alarm Rules	44
8	Network	45
8.1	Network Services	45
8.2	Network Access	45
8.3	Advanced	47
8.4	Network Management	48
8.4.1	Quality of Service	48
8.5	Multicast	48
8.6	IPv4 Filter	49
9	Service	50
9.1	Maintenance	50
9.2	Licenses	51
9.3	Certificates	51
9.4	Logging	51
9.5	Diagnostics	51
9.6	System Overview	52
10	Operation via the browser	53
10.1	Live page	53
10.1.1	Connection	53
10.1.2	PTZ	53
10.1.3	Pre-positions	53
10.1.4	AUX Control	54
10.1.5	Digital I/O	54
10.1.6	Special Functions	55
10.1.7	Recording status	55
10.1.8	Date and Time	55
10.1.9	Full-screen video	55
10.1.10	Saving snapshots	55
10.1.11	Recording live video	56
10.1.12	Video Security App	56
10.1.13	Show latest event	56
10.1.14	Audio communication	56
10.1.15	Storage, CPU and network status	56
10.1.16	Status icons	56
10.2	Playback	57
10.2.1	Selecting the recording stream	57
10.2.2	Searching for recorded video	57
10.2.3	Exporting recorded video	58
10.2.4	Track list	58
10.2.5	Controlling playback	58
10.3	Dashboard	58
11	AUX Commands	59

12	Troubleshooting	61
12.1	Rebooting the unit	63
12.2	Physical reset button	65
12.3	Customer Service and Support	66
13	Decommissioning	67
13.1	Transfer	67
13.2	Disposal	67
14	Support	68

1 Introduction

1.1 System requirements

Our recommendations are:

- Computer with Dual core HyperThreading processor or better
- Graphic card with performance that matches or is better than the resolution of the camera
- Windows 10 or later
- Network access
- Google Chrome, Microsoft Edge, or Mozilla Firefox
- **- or -**
- Application software, for example, Video Security Client, Bosch Video Client or BVMS.

1.2 Establishing the connection

The unit must have a valid IP address and a compatible subnet mask to operate on your network. By default, DHCP is pre-set at the factory to **On** and so your DHCP server assigns an IP address. With no DHCP server the default address is 192.168.0.1

The Project Assistant app or Configuration Manager (version 7.50 or higher) can be used to find the IP address. Download the software from <https://downloadstore.boschsecurity.com>:

1. Start the web browser.
2. Enter the IP address of the device as the URL.
3. During the initial installation, confirm any security questions that show.

IP cameras from Bosch have many ways to connect.

The core communication protocol is called RCP+ (Remote Control Protocol plus), which handles the connections between camera and connected clients.

Every camera can handle a maximum of 128 RCP+ connections, from which a few are used internally, making 100+ external RCP+ connections possible for unicast, multi-unicast, or multicast connections.

A video connection also requires one or two such connections, depending on the access method. Assuming the accumulated requested bitrate does not exceed the available network interface bandwidth, a minimum of five unicast connections is possible.

If a RADIUS server is used for network access control (802.1x authentication), you must configure the device before the device can communicate with the network.

To configure the device, connect it directly to a computer using a network cable and then set the service-level password.

Project Assistant

In order to use this device with the Project Assistant app by Bosch, you must download the app from the Bosch Download Store, from Google Play, or from the Apple Store.

You can access the app in several ways:

- Scan the QR code from the QIG.
- From www.boschsecurity.com, select Support > Apps and Tools > Online Apps - Video > Bosch Project Assistant app. Select the appropriate operating system, and then click the appropriate button to download and install the app.
- From Google Play Store (play.google.com), search for Bosch Project Assistant. Select the app from the list. Click the Install button.
- From Apple Store (itunes.apple.com), search for Bosch Project Assistant. Select the app from the list. Click the appropriate button to download and install the app.

1.3 Establishing the connection

The unit must have a valid IP address to operate on your network and a compatible subnet mask.

By default, DHCP is pre-set at the factory to **On plus Link-Local** so a DHCP server assigns an IP address or, if no DHCP server is available, a link-local address (auto-IP) is assigned within the range 169.254.1.0 to 169.254.254.255.

You can use the Configuration Manager to find the IP address. Download the software from <http://downloadstore.boschsecurity.com>.

1. Start the Web browser.
2. Enter the IP address of the unit as the URL.
3. During initial installation, confirm any security questions that appear.

Note:

If you cannot connect, the unit may have reached its maximum number of connections.

Depending on the device and network configuration, each unit can have up to 50 web browser connections, or up to 100 connections via Bosch Video Client or BVMS.

1.4 Establishing the connection

The unit must have a valid IP address and a compatible subnet mask to operate on your network. By default, DHCP is pre-set at the factory to **On** and so your DHCP server assigns an IP address. With no DHCP server the default address is 192.168.0.1

The Project Assistant app or Configuration Manager (version 7.50 or higher) can be used to find the IP address. Download the software from <https://downloadstore.boschsecurity.com>:

1. Start the web browser.
2. Enter the IP address of the device as the URL.
3. During the initial installation, confirm any security questions that show.

If a RADIUS server is used for network access control (802.1x authentication), you must configure the device before the device can communicate with the network.

To configure the device, connect it directly to a computer using a network cable and then set the service-level password.

Note:

If you cannot connect, the unit may have reached its maximum number of connections.

Depending on the device and network configuration, each unit can have up to 50 web browser connections, or up to 100 connections via Bosch Video Client or BVMS.

1.5 Configuration with Project Assistant app

You can also use the Project Assistant app to complete the initial configuration of the camera. In order to use this device with the Project Assistant app by Bosch, you must download the app from the Bosch Download Store, from Google Play, or from the Apple Store.

You can access the app in several ways:

- Scan the QR code from the QIG.
- From www.boschsecurity.com, select Support > Apps and Tools > Online Apps - Video > Bosch Project Assistant app. Select the appropriate operating system, and then click the appropriate button to download and install the app.
- From Google Play Store (play.google.com), search for Bosch Project Assistant. Select the app from the list. Click the Install button.

- From Apple Store (itunes.apple.com), search for Bosch Project Assistant. Select the app from the list. Click the appropriate button to download and install the app.

1.6 Password protection in camera

The device is password-protected. The first time that any user accesses the device, the device will prompt the user to set a password at the service level.

The camera requires a strong password. Follow the prompts in the dialog box, which specifies what is required. The system measures the strength of the password that you enter.

When you use Configuration Manager to access your device for the first time, you must set the initial password of the device in Configuration Manager. The Users section (General > Unit Access > Users) displays the message, "Before you can use this device you have to secure it with an initial password."

Note: After you set the initial password, a "lock" icon appears next to the device name in the **Devices** list in Configuration Manager.

You can also launch the device webpage directly. In the device webpage, an initial password page appears, displaying input fields and a password strength gauge.

Enter the user name ("**service**") and a password in the appropriate fields. Refer to the section **User Management** for more information.

After a service-level password is set for the device, the device displays a dialog box that prompts users to enter the user name ("**service**") and the service-level password every time that they access the device.







1. Fill in the fields **User name** and **Password**.
2. Click **OK**. If the password is correct, the desired page appears.

2 System overview

When a connection is established, the **Live** page shows.

The page shows the live video from the camera.



The application bar near the top of the page, below the name of the product or of the product family, displays the following icons:



Icon	Description	Function
	Live	View the live video stream.
	Playback	Play back recorded sequences. This link is only visible if a storage medium has been configured for recording. (With VRM recording, this option is not active.)
	Configuration	Configure the device.
	Dashboard	See detailed system information.
	Links	Navigate to the Bosch download store.
	Logout	Log out of the device.
	Help on this page?	Get context-sensitive help for the page that you are seeing.

2.1 Live page

The **Live** page is used to display the live video stream and control the unit.

Below the live video is a field with the date and time. Below the date / time field is a row of icons related to the video feed.

Icon	Description	Function
	Full-screen video	See the selected stream in full-screen mode; press Esc on the keyboard to return to the normal viewing window.
	Save snapshots	Save individual images from the displayed live video stream in JPEG format on the computer's hard drive. The storage location depends on the configuration of the camera.
	Start recording	Save video sequences from the displayed live video stream on the computer's hard drive. The sequences are recorded at the resolution specified in the encoder configuration. The storage location depends on the configuration of the camera.

Icon	Description	Function
	Start Video Security App	Start the app and use It to view live images, to configure and to operate the device from any location.
	Show latest event	Open the Playback page to see the last recorded important events.

2.2 Playback

The **Playback** page is used for playing back recorded sequences.

2.3 Configuration

The **Configuration** page is used to configure the unit and the application interface.

Making Changes

Each configuration screen shows the current settings. You can change the settings by entering new values or by selecting a predefined value from a list field.

Not every page has a **Set** button. Changes to pages without a **Set** button are set immediately. If a page does show a **Set** button, you must click the **Set** button for a change to take effect.



Notice!

Save each change with the associated **Set** button.

Clicking the **Set** button saves the settings only in the current field. Changes in any other fields are ignored.

Some changes only take effect after the unit is rebooted. In this case, the **Set** button changes to **Set and Reboot**.

1. Make the desired changes.
2. Click the **Set and Reboot** button. The camera reboots and the changed settings are activated.

All settings are backed up in camera memory so they are not lost even if the power fails. The exception is the time settings, which are lost after 1 hour without power if no central time server is selected.

2.4 Dashboard

The **Dashboard** page is used to display detailed information about the device.

The **Dashboard** is only visible in the application bar if the **Show 'Dashboard'** option is enabled by a service-level user in the **Configuration** -> **Web Interface** -> **Appearance** page.

3 General

3.1 Identification

Device name

Enter a unique, unambiguous name for the device (for example, the installation location of the device). This name should be easy to identify in a list of devices in your system. The device name is used for the remote identification of a unit, such as in the event of an alarm.

Do not use any special characters, for example **&**, in the name. Special characters are not supported by the system's internal management.

Device ID

Enter a unique identifier for the device. This ID is additional identification for the device.

Video name

Enter a name for the video (for example, HDR ON).

Host name

Enter a host name.

Initiator extension

Add text to an initiator name to make identification easier in large iSCSI systems. This text is added to the initiator name, separated from it by a full stop. (You can see the initiator name in the System Overview page.)

3.2 User Management

The section **Authentication modes** provides information about the authentication modes set in the camera. A checkmark appears in the checkbox to the left of the mode if the mode is set. If the mode is not set, the phrase, "**No certificate installed**" appears to the right of the mode name.

Password

This field indicates if a password is set for the camera.

Certificate

A check mark in this check box indicates that at least one certificate is loaded onto the camera. If no certificates are loaded, then "No certificate installed" appears to the right of the text.

The Escript certificate is a root certificate for Bosch Security Systems that proves that the device meets the following criteria:

- It originates from a Bosch factory that is a secure environment.
- It has not been tampered with.

Escript is a Bosch company and Certificate Authority (CA).

Active directory server (ADFS)

A check mark in this check box indicates that the camera uses an active directory server. If the camera does not use ADFS, then "No certificate installed" appears to the right of the text.

Password management

A password prevents unauthorized access to the device. You can use different authorization levels to limit access.

Proper password protection is only guaranteed when all higher authorization levels are also protected with a password. Therefore, you must always start from the highest authorization level when assigning passwords.

You can define and change a password for each authorization level if you are logged into the "service" user account.

The device has three authorization levels: service, user, and live.

- service is the highest authorization level. Entering the correct password gives access to all the functions and allows all configuration settings to be changed.
- user is the middle authorization level. At this level you can operate the device, play back recordings, and also control camera, for example, but you cannot change the configuration.
- live is the lowest authorization level. At this level you can only view the live video image and switch between the different live image displays.

A fourth user group, **VCA configuration**, has the privilege to configure VCA only.

Note: Configuration and use of this user group is available only in Configuration Manager (7.20 or later).

To edit a password

To edit a password, click the pencil icon to the right of the column **Type** for the appropriate **User name**.

To create a new user

To create a new user, click **Add**.

In the box **User**, fill in the fields. For Group, select the appropriate authorization level. For **Type**, select either **Password** (for a new password) or **Certificate** (for a certificate that the new user is authorized to use).

Note: Use a maximum of 19 characters. Do not use special characters.

Confirm password

In each case, enter the new password a second time to eliminate typing mistakes.



Notice!

A new password is only saved when you click the **Set** button. You should therefore click the **Set** button immediately after entering and confirming a password.

3.3

Date/Time

Date format

Select the required date format from the dropdown menu.

Device date/Device time



Notice!

Make sure that recording is stopped before synchronizing to the PC.

If there are multiple devices operating in your system or network, it is important to synchronize their internal clocks. For example, it is only possible to identify and correctly evaluate simultaneous recordings when all units are operating on the same time.

1. Enter the current date. Since the unit time is controlled by the internal clock, there is no need to enter the day of the week - it is added automatically.
2. Enter the current time or click the **Sync to PC** button to copy your computer's system time to the camera.

Note: It is important that the date/time is correct for recording. An incorrect date/time setting could prevent correct recording.

Device time zone

Select the time zone in which the system is located.

Daylight saving time

The internal clock can switch automatically between normal and daylight saving time (DST). The unit already contains the data for DST switch-overs for many years in advance. If the date, time and zone have been set up correctly, a DST table is automatically created. If you decide to create alternative daylight saving time dates by editing the table, note that values occur in linked pairs (DST start and end dates).

First, check the time zone setting. If it is not correct, select the appropriate time zone and click **Set**.

1. Click **Details** to edit the DST table.
2. Select the region or the city which is closest to the system's location from the list box below the table.
3. Click **Generate** to fill the table with the preset values from the unit.
4. Click one of the entries in the table to make changes. The entry is highlighted.
5. Click **Delete** to remove the entry from the table.
6. Choose other values from the list boxes under the table, to change the selected entry. Changes are immediate.
7. If there are empty lines at the bottom of the table, for example after deletions, add new data by marking the row and selecting values from the list boxes.
8. When finished, click **OK** to save and activate the table.

Time server address

The camera can receive the time signal from time server using various time server protocols, and then use it to set the internal clock. The unit polls the time signal automatically once every minute.

Enter the IP address of a time server here.

You can choose to have the DHCP server give a time server date by selecting the **Overwrite by DHCP** option.

Time server type

Select the protocol that is supported by the selected time server.

- Select **Time protocol** if the server uses the protocol RFC 868.
- The **SNTP protocol** supports a high level of accuracy and is required for special applications and subsequent function extensions.
- Select **TLS protocol** if the server uses the RFC 5246 protocol.
- Select **Off** to disable the time server.

Click **Set** to apply the changes.

4 Web Interface

4.1 Appearance

You can adapt the appearance of the web interface and change the website language to meet your requirements.

Website language

Select the language for the user interface.

The default language is English. After selecting a different language, click the **Set** button. The page refreshes automatically. The GUI now displays field names and options as well as OSD messages in the selected language.

Show VCA metadata

When video content analysis (VCA) is activated, additional information is displayed in the live video stream. With the MOTION+ analysis type, for example, the sensor fields in which motion is recorded are marked with yellow rectangles.

Using Essential Video Analytics or Intelligent Video Analytics, the outlines of detected objects are displayed in following colors:

- Red: Objects that generate an alarm event under the current settings appear on the camera image inside a red outline.
- Orange: An object that has triggered one alarm event but does not generate another appears inside an orange outline (example: object has crossed a line). During forensic search, an object that triggers an alarm event has an orange outline from the beginning.
- Yellow: Objects that are detected as moving but do not generate an alarm event under the current settings appear inside a yellow outline.

Show VCA trajectories

The trajectories (motion lines of objects) from the video content analysis are displayed in the live video image if a corresponding analysis type is activated. The trajectory is shown as a green line following the object base point.

Show overlay icons

Select this check box to show overlay icons on the live video image.

Show VCA items

Shows alarm fields, lines and routes configured for the video analytics in the following colors:

- Green: Fields, lines and routes used in a task are displayed in green. They can be edited but not deleted.
- Red: Fields, lines and routes currently in alarm mode are displayed in red.

Show 'Dashboard'

Select this checkbox to enable the **Dashboard** in the application bar.

Secure cookies

Select this checkbox to secure the cookies sent through the camera.



Notice!

If cookies are secured, authentication forwarding to MPEG ActiveX and the Video Security App is prohibited.

Video player

Select the type of player to be used for live mode viewing.

Latency mode**Video buffer**

The value shown is calculated from the **Latency mode** setting. It cannot be changed.

JPEG resolution

Select the size of the JPEG image on the **Live** page. Options are **Small**, **Medium**, **Large**, 720p, Maximum, and **Resource based**.

JPEG interval

You can specify the interval at which the individual images should be generated for the M-JPEG image on the **Live** page.

JPEG quality

You can specify the quality at which the JPEG images appear on the **Live** page.

4.2

'Live' functions

On this page you can adapt the functions on the **LIVE** page to your requirements. You can choose from a variety of different options for displaying information and controls.

1. Check the box for the items that are to be made available on the **LIVE** page. The selected items are indicated by a check mark.
2. Check whether the required functions are available on the **LIVE** page.

Transmit audio

You can only select this option if audio transmission is actually switched on (see Audio). The audio signals are sent in a separate data stream parallel to the video data, and so increase the network load. The audio data are encoded according to G.711 and require an additional bandwidth of approx. 80 kbps per connection in each direction.

Auto logout time [min]

Set a time frame (in minutes) for the automatic logout. Default value is 0 (no automatic logout).

Show 'AUX Control'

Here you can specify whether the **Live** page displays the section **Show 'AUX Control'**.

Show 'Intelligent Tracking'**Path for JPEG and video files**

Enter the path for the storage location of individual images and video sequences saved from the **Live** page.

Video file format

Select a file format for the live page display. The MP4 format does not include metadata.

5

Camera

5.1

Installer Menu

Sensor mode

The sensor mode specifies the base resolution and frame rates for the image quality settings. Fast moving scenes use more frame rates (50 fps or 60 fps) for better image quality than slow moving scenes. Adjust this setting as necessary.

This higher resolution (HD 1080p) gives maximum detail in these scenes, but can result in motion artifacts for fast-moving objects because of the lower frame rates.

Some types of light can show flickering in the image when the frame rate is not synchronized with the mains power frequency. To avoid this, the sensor mode frame rate should be in line with the power frequency:

- 50Hz: 25 or 50 fps
- 60Hz: 30 or 60 fps

Select the appropriate option:

- 25fps - 3.7 MP 16:9 - HDR X
- 30fps - 3.7 MP 16:9 - HDR X
- 50fps - 3.7 MP 16:9
- 60fps - 3.7 MP 16:9



Notice!

Changing the field **Sensor mode**

A change to the parameter in the field **Sensor mode** requires approximately 10-20 seconds to complete. During this time, no changes can be made. The cameo image freezes.

Image rotation

To invert the live video image (because the camera is mounted in inverted orientation), select 180°.

If the camera is mounted upright, select 0°.

Mirror image

Select **On** to output a mirror image of the camera picture.

Note: Privacy masks are not supported in mirror image mode.

Coding standard

Select the encoding mode, H.264 or H.265 .

Camera LED

Select **Auto disable** to let the camera determine when the LED should be switched off.

Select **Enabled** to start the **Camera LED**.

Select **Disabled** to stop the **Camera LED**.

Reboot device

Click **Reboot** to restart the device.

Restore settings

Click **Restore** to restore the factory defaults of the device.

Note: Clicking this button also clears the service-level password. Operators must reset the password before doing anything else.

Restore settings

Click **Defaults** to restore the factory defaults for the camera. A confirmation screen appears.

Allow several seconds for the camera to optimize the picture after a reset.

Click **Confirm** in each dialog box that opens to complete a factory reset of the device.

This action resets all settings to defaults (including network settings).

5.1.1

Display Stamping

Various overlays or “stamps” in the video image provide important supplementary information. These overlays can be enabled individually and are arranged on the image in a clear manner. The drop-down menus below allow the configuration of the individual stamping options. The respective sample windows show a preview of the configured text and background styles. Click **Set** to apply the changes.

Global configuration



Notice!

These options can also be configured individually for all stamping settings. Any changes to the global configuration settings will be applied to all stamping settings!

Camera name stamping

Select the position of the camera name overlay in the drop-down box. It can be displayed at the **Top**, at the **Bottom**, or at a position of choice using the **Custom** option, or it can be set to **Off** for no overlay information.

If the **Custom** option is selected, enter values in the X and Y position fields.

Stamping size

Select the desired font size of the overlays on the OSD: **Normal** or **Large**.

Select **Custom** to enable the **Font size (%)** field.

Font size

Enter a number for a custom size (percentage) of the font, from 1 to 1000.

Text color

Select the color for the alarm message to be displayed in.

Background color

Select the background color for the alarm message to be displayed in.

If you have enabled the **Transparent background** option, the background color is not displayed in the OSD.

Transparent background

Check this box to make transparent the stamp background on the image.

Optionally, tick the **Underlay with full-width bar** box to place a full-width background-bar beneath the time stamp.

Logo stamping

Logo position

Select the position for the logo on the OSD: **To the left of the name**, **To the right of the name**, or **Logo only**.

Select **Off** (the default value) to disable logo positioning.

– Transparent background

Enable this option to hide the logo's background.

To place a logo on the image, select and upload an uncompressed .bmp file with a maximum size of 1024 x 1024 pixels and 16M colors to the camera.

Time stamping

Select the position of the time and date overlay in the drop-down box. It can be displayed at the **Top**, at the **Bottom**, or at a position of choice using the **Custom** option, or it can be set to **Off** for no overlay information.

If the **Custom** option is selected, enter values in the X and Y position fields.

Stamping size

Select the desired font size of the overlays on the OSD: **Normal** or **Large**.

Select **Custom** to enable the **Font size (%)** field.

Font size

Enter a number for a custom size (percentage) of the font, from 1 to 1000.

Text color

Select the color for the alarm message to be displayed in.

Background color

Select the background color for the alarm message to be displayed in.

If you have enabled the **Transparent background** option, the background color is not displayed in the OSD.

Transparent background

Check this box to make transparent the stamp background on the image.

Display milliseconds

If necessary, you can display milliseconds. This information can be useful for recorded video images; however, it does increase the processor's computing time.

Select **Off** if you do not need to display milliseconds.

This option is only available if **Time stamping** is enabled.

Note: The time stamp (with or without the display of Milliseconds) on the OSD is the indication to camera operators that the camera is showing live video, that the image is not frozen.

Alarm mode stamping

Select **On** to display a text message overlay in the image in the event of an alarm. It can be displayed at a position of your choice that you can then specify using the **Custom** option. Or it can be set to **Off** for no overlay information.

1. Select the desired option from the list.
2. If you select the **Custom** option, additional fields are displayed where you can specify the exact position (**Position (XY)**).
3. In the **Position (XY)** fields, enter the values for the desired position.

Stamping size

Select the desired font size of the overlays on the OSD: **Normal** or **Large**.

Select **Custom** to enable the **Font size (%)** field.

Font size

Enter a number for a custom size (percentage) of the font, from 1 to 1000.

Alarm message

Enter the message to be displayed in the image in the event of an alarm. The maximum text length is 31 characters.

Text color

Select the color for the alarm message to be displayed in.

Background color

Select the background color for the alarm message to be displayed in.

If you have enabled the **Transparent background** option, the background color is not displayed in the OSD.

Transparent background

Check this box to make transparent the stamp background on the image.

Info stamping**Enable****Stamping size**

Select the desired font size of the overlays on the OSD: **Normal** or **Large**.

Select **Custom** to enable the **Font size (%)** field.

Font size

Enter a number for a custom size (percentage) of the font, from 1 to 1000.

Text color

Select the color for the alarm message to be displayed in.

Background color

Select the background color for the alarm message to be displayed in.

If you have enabled the **Transparent background** option, the background color is not displayed in the OSD.

Transparent background

Check this box to make transparent the stamp background on the image.

Live video indicator

Select **On** to display the **Live video indicator**, an icon that pulses on the OSD to show that the video stream is live.

Select **Off** to hide the **Live video indicator**.

Title region

Select **On** to set or to edit the position of the **Title region** on the **OSD**.

The fields **Position (XY)** and **(0...255)** appear.

1. In the field **Position (XY)**, specify the exact position. (The default is 10.)

2. In the field **(0...255)**, enter the position range. (The default is 176).

Select **Off** to hide the region from view.

Stamping size

Select the desired font size of the overlays on the OSD: **Normal** or **Large**.

Select **Custom** to enable the **Font size (%)** field.

Font size

Enter a number for a custom size (percentage) of the font, from 1 to 1000.

Text color

Select the color for the alarm message to be displayed in.

Background color

Select the background color for the alarm message to be displayed in.

If you have enabled the **Transparent background** option, the background color is not displayed in the OSD.

Transparent background

Check this box to make transparent the stamp background on the image.

Telemetry region

Select **On** to set or to edit the position of the telemetry information (azimuth and elevation (pan/tilt position)) and the zoom factor on the **OSD**. Refer to the section "PTZ Settings, page 26" to set the pan and tilt limits.

The fields **Position (XY)** and **(0...255)** appear.

1. In the field **Position (XY)**, specify the exact position. (The default is 10.)

2. In the field **(0...255)**, enter the position range. (The default is 176).

Select **Off** to hide the region from view.

Stamping size

Select the desired font size of the overlays on the OSD: **Normal** or **Large**.

Select **Custom** to enable the **Font size (%)** field.

Font size

Enter a number for a custom size (percentage) of the font, from 1 to 1000.

Text color

Select the color for the alarm message to be displayed in.

Background color

Select the background color for the alarm message to be displayed in.

If you have enabled the **Transparent background** option, the background color is not displayed in the OSD.

Transparent background

Check this box to make transparent the stamp background on the image.

Feedback region

Select **On** to set or to edit the position of system feedback messages (including message for camera settings such as focus, iris, and zoom level) on the **OSD**. Refer to the section “**Lens Settings**” to configure these settings.

The fields **Position (XY)** and **(0...255)** appear.

1. In the field **Position (XY)**, specify the exact position. (The default is 10.)
2. In the field **(0...255)**, enter the position range. (The default is 176).

Select **Off** to hide the region from view.

Stamping size

Select the desired font size of the overlays on the OSD: **Normal** or **Large**.

Select **Custom** to enable the **Font size (%)** field.

Font size

Enter a number for a custom size (percentage) of the font, from 1 to 1000.

Text color

Select the color for the alarm message to be displayed in.

Background color

Select the background color for the alarm message to be displayed in.

If you have enabled the **Transparent background** option, the background color is not displayed in the OSD.

Transparent background

Check this box to make transparent the stamp background on the image.

Stream security**Video authentication**

Select from the **Video authentication** drop-down box a method for verifying the integrity of the video.

If you select **Watermarking**, all images are marked with an icon. The icon indicates if the sequence (live or saved) has been manipulated.

If you want to add a digital signature to the transmitted video images to ensure their integrity, select one of the cryptographic algorithms for this signature.

Signature interval [s]

For certain **Video authentication** modes, enter the interval (in seconds) between insertions of the digital signature.

5.1.2

Positioning

The **Positioning** feature describes the location of the camera and the perspective in the camera's field of view.

Perspective information is essential to Video Analytics, as it enables the system to compensate for the illusory smallness of distant objects.

Only through use of perspective information is it possible to distinguish objects such as persons, bicycles, cars and trucks, and accurately compute their real size and speeds as they move through 3D space.

However, to calculate perspective information accurately, the camera must be directed at a single, flat horizontal plane. Multiple and inclined planes, hills, stairs can falsify perspective information and produce incorrect object information such as size and speed.

Mounting position

The mounting position describes the perspective information that is also often called calibration.

In general, the mounting position is determined by the parameters of the camera such as height, roll angle, tilt angle, and focal length.

The height of the camera must always be entered manually. Whenever possible, roll angle and tilt angle are provided by the camera itself. The focal length is provided, if the camera has a built-in lens.

Select the appropriate mounting position of the camera. Options that appear depend on the type of camera.

Height [m]

The height describes the vertical distance from the camera to the ground plane of the captured image. Typically the elevation of the mounted camera above the ground.

Enter the height in meters of the position of the camera.

Coordinate system

The **Coordinate system** feature describes the position of the camera in a local **Cartesian** or the global **WGS 84** coordinate system. The camera and the objects tracked by the video analytics are displayed on a map.

Select the coordinate system and enter the appropriate values in the additional input fields that appear depending on the coordinate system selected.

Cartesian

The Cartesian coordinate system describes each point in the space by a combination of the position on three orthogonal axes X, Y and Z. A right-handed coordinate system is used, where X and Y span the ground plane and Z describes the elevation of the ground plane.

X [m]

The location of the camera on the ground on the X-axis.

Y [m]

The location of the camera on the ground on the Y-axis.

Z [m]

The elevation of the ground plane. To determine the elevation of the camera, add the **Z [m]** value and the **Height [m]** value of the camera.

WGS 84

The WGS 84 coordinate system is a spherical coordinate system description of the world and used in many standards including GPS.

Latitude

Latitude is the north-south position of the camera in the spherical coordinate system WGS 84.

Longitude

Longitude is the east-west position of the camera in the spherical coordinate system WGS 84.

Ground level [m]

The elevation of the ground above sea level. To determine the elevation of the camera, add the **Ground level [m]** value and the **Height [m]** value of the camera.

Azimuth [°]

The orientation of the camera in a counter-clockwise angle starting with 0° in the east (WGS 84) or on the X-axis (**Cartesian**). If the camera is directed towards the north (WGS 84) or the Y-axis (Cartesian), the azimuth is 90°.

5.2**Encoder Profile**

For the video signal encoding, you can select a code algorithm and you can change the presets for the profiles.

You can adapt the video data transmission to the operating environment (for example network structure, bandwidth, data load). To this end, the camera simultaneously generates two data streams (Dual Streaming), which compression settings you can select individually, for example one setting for transmissions to the Internet and one for LAN connections.

Pre-programmed profiles are available, each giving priority to different perspectives.

You can change individual parameter values of a profile and you can also change the name.

You can switch between profiles by clicking the appropriate tabs.

**Caution!**

The profiles are rather complex. They include a large number of parameters that interact with one another, so it is generally best to use the default profiles.

Change the profiles only once you are fully familiar with all the configuration options.

Note: In the default setting, Stream 1 is transmitted for alarm connections and automatic connections.

**Notice!**

All parameters combine to make up a profile and are dependent on one another. If you enter a setting that is outside the permitted range for a particular parameter, the nearest permitted value will be substituted when the settings are saved.

Profile name

If required, enter a new name for the profile.

Bit rate optimization

The bit rate optimization defines the optimization strength. These must be combined with the appropriate scene mode. The **Bit rate optimization** and **Maximum bit rate** work in a quality-driven mode. The encoder generates a bit rate up to the maximum setting if the scene requires it.

For maximum image quality, apply minimum bit rate reduction (**Maximum quality**). This will also greatly increase the file size. If maximum bit rate reduction is applied, the image will have less quality, but the file size decreases significantly (**Minimum bit rate**).

Select the necessary bit rate optimization setting:

- **Off:** bit rate optimization is disabled
- **Maximum quality**
- **High quality**
- **Medium**
- **Low bit rate**

– **Minimum bit rate**

Averaging period

Select the appropriate averaging period as a means of stabilizing the long term bit rate.

Target bit rate

To optimize use of the bandwidth in the network, limit the data rate for the device. The target data rate should be set according to the desired picture quality for typical scenes with no excessive motion.

For complex images or frequent changes of image content due to frequent movements, this limit can temporarily be exceeded up to the value entered in the **Maximum bit rate** field.

Note: You can change the value in this field only if you select a duration in the field **Averaging period**. If you do not select an **Averaging period**, then the field **Target bit rate** is greyed out.

Frame rate

Set the desired value using the slider.

Note: A higher frame rate makes motion sequences smoother but requires more disk space. A lower frame rate, achieved by skipping frames, requires less disk space but makes motion sequences less smooth.

Video resolution

Select the desired resolution for the video image.

Note: The value in this field adjusts the resolution for SD streams only.

Advanced settings

If necessary, use the expert settings to adapt the I-frame quality and the P-frame quality to specific requirements. The setting is based on the H.264 quantization parameter (QP).

I-frame distance

Use the slider to set the distance between I-frames to **Auto** or to between **3** and **255**. An entry of 3 means that every third image is an I-frame. The lower the number, the more I-frames are generated.

Note that the values supported depend on the GOP structure setting. For example, only even values are supported with IBP; if you have selected IBBP, only 3 or multiples of 3 are supported.

Allow enhanced prediction

This function allows for multiple references in H.264 and H.265 streams, which can reduce bitrate. Some decoders do not support this feature and therefore can be disabled.

Min. P-frame QP

This parameter allows you to adjust the image quality of the P-frame and to define the lower limit for the quantization of the P-frames, and thus the maximum achievable quality of the P-frames. In the H.264-protocol, the Quantization Parameter (QP) specifies the degree of compression and thus the image quality for every frame. The lower the quantization of the P-frame (QP value), the higher the encoding quality (and thus the best image quality) and the lower the frame refresh rate depending on the settings for the maximum data rate under network settings. A higher quantization value results in low image quality and lower network load. Typical QP values are between 18 and 30.

The basic setting Auto automatically adjusts the quality to the settings for the P-frame video quality.

I/P-frame delta QP

This parameter sets the ratio of the I-frame quantization (QP) to the P-frame quantization (QP). For example, you can set a lower value for I-frames by moving the slide control to a negative value. Thus, the quality of the I-frames relative to the P-frames is improved. The total data load will increase, but only by the portion of I-frames. The basic setting Auto automatically adjusts to the optimum combination of movement and image definition (focus). To obtain the highest quality at the lowest bandwidth, even in the case of increased movement in the picture, configure the quality settings as follows:

1. Observe the coverage area during normal movement in the preview images.
2. Set the value for **Min. P-frame QP** to the highest value at which the image quality still meets your needs.
3. Set the value for **I/P-frame delta QP** to the lowest possible value. This is how to save bandwidth and memory in normal scenes. The image quality is retained even in the case of increased movement since the bandwidth is then filled up to the value that is entered under **Maximum bit rate**.

Background delta QP

Select the appropriate encoding quality level for a background region defined in Encoder Regions. The lower the QP value, the higher the encoding quality.

Object delta QP

Select the appropriate encoding quality level for an object region defined in Encoder Regions. The lower the QP value, the higher the encoding quality.

Default

Click **Default** to return the profile to the factory default values.

5.3**Encoder Streams**

The camera has 3 fully configurable streams, with the option to activate or deactivate VCA overlays on each stream.

Note: If you access this menu while the camera is recording, the following message appears at the top of the page: Recording is currently active. Therefore, for 'Current profile' the respective stream profile selected for recording is displayed for information.

For each stream, select the appropriate options in the fields that follow.

Active profile

Options are:

- 2MP - 1920x1080 (16:9)
- 1.3MP - 1536x864 (16:9)
- 1MP - 1280x720 (16:9)
- 0.4MP - 704x576 (4:3) crop
- 0.3MP - 704x480 (4:3) crop
- 0.3MP - 768x432 (16:9)
- VGA - 640x480 (4:3) crop
- 0.1MP - 512x288 (16:9)

If you selected **2560x1440 (3.7 MP)**, the options for **Stream 2** are:

- **Copy Stream 1**
- **1080p (2 MP)**
- **1536x864 (1.3 MP)**
- **720p (1 MP)**
- **SD**
- **D1 4:3 (cropped)**
- **640x480**

Non-recording profile

Select one of the following profiles for each stream:

Note: Non-recording profiles (streams) are I-frame only.

Note: Each stream can have its own independent profile which does not need to be shared with other streams.

Options include Off, On, or Privacy mode.

This functionality has no effect on video processed by 3rd party apps.

Select **Off** to stop **VCA overlays** on the stream.

Select **On** to start **VCA overlays** on the stream.

Select **Privacy mode** to use **VCA overlays** with **Privacy Masks**.

Click **Frame and bit rate test** to see when and if a specific stream will drop frames.

Click **Set** to apply the changes.

5.4 Encoder Statistics

Stream

Identifies the current stream (1, 2, or 3).

Zoom

Identifies the current zoom factor of the camera (1x, 2x, 4x, or 8x).

Averaging period

Select the appropriate averaging period as a means of stabilizing the long term bit rate.

5.5 Lens Settings

Focus

Focus speed

Use the slider (from 1 to 8) to control how fast the Auto focus will readjust when the focus becomes blurred.

IR focus correction

Optimizes the focus for IR lighting. Options are: On, Off (default).

Zoom

Maximum zoom speed

Controls the zoom speed.

Zoom limit

Select the appropriate limit for zooming the camera: 20x, 30x, or 40x.

Digital zoom

Digital zoom is a method of decreasing (narrowing) the apparent angle of view of a digital video image. It is accomplished electronically, without any adjustment of the camera's optics, and no optical resolution is gained in the process.

Select **On** to enable this feature.

Select **Off** to disable this feature.

5.6 PTZ Settings

Auto pan speed

Continuously pans the camera at a speed between right and left limit settings. Type a value between 1 and 60 (expressed in degrees), inclusive. The default setting is 30.

Inactivity

Selects the time period the dome must be not controlled until the inactivity event will be executed.

- **Off** (default): camera remains on a current scene indefinitely.
- **Pre-position 1**: camera returns to **Pre-position 1**.
- **Previous AUX**: camera returns to the previous AUX activity.

Inactivity period

Determines the behavior of the camera when the control for the camera is inactive. Select a time period from the pull-down list (3 s - 24 h). The default setting is 30 seconds.

Auto pivot

The Auto pivot tilts the camera through the vertical position as the camera is rotated to maintain the correct orientation of the image. Set the Auto Pivot to On (default) to automatically rotate the camera 180° when following a subject traveling directly beneath the camera. To disable this feature, click Off.

Freeze frame

Select On to freeze the image while the camera moves to a predetermined scene position.

Tour A / Tour B

Starts and stops the recording of a recorded (guard) tour.

The camera can make up to two (2) recorded tours. A recorded tour saves all manual camera movements made during the recording, including its rate of pan, tilt and zoom speeds, and other lens setting changes. The tour does not capture camera video during the recording of the tour.

Note 1: You can save a total of 15 minutes of recorded actions between the two tours.

To record a tour:

1. Click the Start Recording button. The system prompts you to overwrite the existing tour.
2. Click Yes to overwrite the existing tour movements.
3. Click the View Control link, under the image cameo, to access the directional and zoom controls.
4. Use the View Control dialog box to make the necessary camera movements.
5. Click the Stop Recording button to save all actions.

Note: **Tour B** is now intended for use with the 'IVA while moving' functions.

You must first calibrate the camera to North before the camera displays accurate compass headings. The camera uses this calibration, usually set to magnetic North, as the zero degree pan position and as the North compass heading. The camera then displays the compass heading based on the number of degrees from the North calibration point.

To set the North calibration point:

1. Determine the North compass heading, then move the camera to that position.
2. Select the radio button **On** for the parameter **Compass**.
3. Click the button next to **North point** to set the calibration point.

North point

- Click the **Set** button to overwrite the existing **North point**. A dialog box appears with the message, "Overwrite **North point**?" To confirm, click **OK**. To cancel, click **Cancel**.
- Click the **Clear** button to reset the **North point** to factory defaults. A dialog box appears with the message, "Reset **North point** to factory defaults?" To confirm, click **OK**. To cancel, click **Cancel**.

Alternative home position

Click **Set** to set the alternative home position for the camera.

Click **Clear** to clear the alternative home position.

5.7 Pre-positions and Tours

The camera can store up to 256 preset scenes. You can define the individual scenes that comprise a **Pre-position Tour**.

You define individual pre-position scenes, then use these scenes to define the **Pre-position Tour**. The tour starts from the lowest scene number in the tour and progresses sequentially to the highest scene number in the tour. The tour displays each scene for a specified dwell time before advancing to the next scene.

By default, all scenes are part of the **Pre-position Tour** unless removed.

To define and edit an individual pre-position:

1. Set the pre-position in the video image.
 - Use the PTZ controls to move the camera into position.
 - Using the Live preview window as reference, navigate to the scene that you want to define as a pre-position.
2. Click the button **Add pre-position** (“+”) to define the pre-position.
3. Select a number for the pre-position, from 1 to 256.
4. Type an optional name for the pre-position, up to 20 characters long.
5. Click OK to save the pre-position to the list **Pre-positions**.
6. To include the pre-position in a standard tour, select the check box to the left of the field **“Include in standard tour (marked with *)”**. An asterisk (*) appears to the left of the name in the list **Pre-positions**.
7. For IR cameras only: To add IR light to the pre-position, select the check box to the left of the field **“IR light (marked with #)”**.
8. To delete a pre-position from the list, select the pre-position and click the button **Delete pre-position** ().
 - Use the PTZ controls to navigate to the new pre-position.
 - In the list **Pre-positions**, select the pre-position that you want to overwrite.
 - Click the button **Overwrite pre-position** (disk icon) to apply the new pre-position to the existing pre-position.
 - To change the name of the pre-position, double-click the pre-position in the list. Then, change the name in the dialog box **Edit Pre-position** and click OK.
9. To view a pre-position in the preview window, select the pre-position in the list and click the button **Show pre-position** (eye icon).
10. To view a pre-position from the **Live** page:
 - Click a pre-position number in the list **Pre-positions**.
 - OR
 - Use the keypad and the button **Show pre-position in AUX Control**.

To define a Pre-position Tour:

1. Create the individual pre-positions.

By default, all scenes in the list **Pre-positions** are in the **Pre-position Tour**.
2. To remove a pre-position from the tour, select the pre-position in the list and uncheck the box **Include in standard tour (marked with *)**.
3. Select a dwell time from the drop-down list **Standard pre-position tour**.
4. To start the **Pre-position Tour**:

Return to the **Live** page.

Click **AUX Control**.

Type **8** in the input box and click **AUX on**.

5. To stop the tour, type **8** and click **AUX off**.

To define a Custom tour

1. Create the individual pre-positions.
2. To add a pre-position into the custom tour, select the pre-position from the general list and click the triangle button to copy it to the custom tour list.
3. Adjust the custom tour sequence by moving preposition up or down.
4. Select a dwell time from the drop-down list **Custom tour**.
5. To start the **Custom tour**:
Return to the **Live** page.
Select **Special Functions**.
Click **AUX Control**.
Type 7 in the input box and click **AUX on**.
6. To stop the tour, type 7 and click **AUX off**.

Sequence settings

Include in standard tour (marked with *)

Select this checkbox to include the pre-position in the standard tour.

Upload

Click the button to upload the tour configuration to the camera.

Dwell times

Standard pre-position tour

Select the dwell time in seconds or minutes for the **Standard pre-position tour**.

Custom pre-position tour

Select the dwell time in seconds or minutes for the **Custom pre-position tour**.

5.8 Sectors

Sector

The camera's pan capability is divided into 16 sectors, for a total of 360°.

To define a title for sectors:

1. Place the cursor in the input box to the right of the sector number.
2. Type a title for the sector, up to 20 characters long.
3. To blank the sector, click the check box to the right of the sector title.

5.9 Miscellaneous

Fast address

This parameter allows the appropriate camera to be operated via the numerical address in the control system. Enter a number between 0000 and 9999, inclusive, to identify the camera.

5.10 Audio

Audio

You can set the gain of the audio signals to suit your specific requirements. The live video image is shown in the window to help you check the audio source. Your changes are effective immediately.

If you connect via Web browser, you must activate the audio transmission on the **'Live' functions** page. For other connections, the transmission depends on the audio settings of the respective system.

The audio signals are sent in a separate data stream parallel to the video data, and so increase the network load. The audio data is encoded according to the selected format and requires additional bandwidth. If you do not want any audio data to be transmitted, select **Off**.

Input volume

Set the input volume using the slide. Values range from 0 to 119.

Line Out

Set the line output gain using the slider. Values range from 0 to 115.

Recording format

Select a format for audio recording. The default value is **AAC 48 kbps**. You can select **AAC 80 kbps**, G.711 or L16 depending on the required audio quality or sampling rate.

AAC audio technology is licensed by Fraunhofer IIS.

(<http://www.iis.fraunhofer.de/amm/>)

5.11

Pixel Counter

The number of horizontal and vertical pixels covered by the highlighted area is displayed below the picture. With these values you can check whether the requirements for specific functions, for example, identification tasks, are fulfilled.

1. Click **Freeze** to freeze the camera image if the object that you want to measure is moving.
2. To reposition a zone, place the cursor over the zone, hold down the mouse button and drag into position.
3. To change the shape of a zone, place the cursor over the edge of the zone, hold down the mouse button and drag the edge of the zone to the required position.

6 Recording

6.1 Introduction to recording

Images can be recorded to an appropriately configured iSCSI system or, for devices with an SD slot, locally to an SD card.

SD cards are the ideal solution for shorter storage times and temporary recordings. They can be used for local alarm recording or to improve the overall reliability of video recording. For long-term authoritative images use an appropriately sized iSCSI system.

Two recording tracks are available (**Recording 1** and **Recording 2**). The encoder streams and profiles can be selected for each of these tracks for both standard and alarm recordings. Ten recording profiles are available where these recording tracks can be defined differently. These profiles are then used for building schedules.

A Video Recording Manager (VRM) can control all recording when accessing an iSCSI system. The VRM is an external program for configuring recording tasks for video servers.

6.2 Storage Management

6.2.1 Device manager

An external Video Recording Manager (VRM) system for the unit is configured via the Configuration Manager. The **Managed by Video Recording Manager software** box is only an indicator; it cannot be changed here.

If the **Managed by Video Recording Manager software** box is checked, you are not able to configure any further recording settings on this page.

6.2.2 Recording media

Select a media tab to connect to the available storage media.

iSCSI Media

To use an **iSCSI system** as the storage medium, a connection to the desired iSCSI system is required to set the configuration parameters.

The storage system selected must be available on the network and completely set up. It must have an IP address and be divided into logical drives (LUNs).

1. Enter the IP address of the required iSCSI destination in the **iSCSI IP address** field.
2. If the iSCSI destination is password protected, enter the password into the **Password** field.
3. Click **Read**.
 - The connection to the IP address is established.

The **Storage overview** field displays the logical drives.

Local Media

An SD card inserted in the camera can be used for local recording.

- To use the SD card for Automatic Network Replenishment (ANR), select the check box.
- If the SD card is password-protected, enter the password into the **Password** field.

The **Storage overview** field displays the local media.

Note: The recording performance of the SD card depends on the speed (class) and the performance of the SD card. Bosch recommends an SD card of Class 6 or higher.

Note: For more information about Automatic Network Replenishment (ANR), refer to the White Paper “ANR 2.0 Automatic Network Replenishment (ANR),” available on the product page for your camera. Access the product page on the online product catalog through the appropriate link from <https://www.boschsecurity.com/xc/en/product-catalog/>.

6.2.3 Activating and configuring storage media

Available media or iSCSI drives must be transferred to the **Managed storage media** list, activated, and configured for storage.

Note:

An iSCSI target storage device can only be associated with one user. If a target is being used by another user, ensure that the current user no longer needs the target before decoupling that user.

1. In the **Storage overview** section, double-click a storage medium, an iSCSI LUN or one of the other available drives.
 - The medium is added as a target in the **Managed storage media** list.
 - Newly added media is shown as **Not active** in the **Status** column.
2. Click **Set** to activate all media in the **Managed storage media** list.
 - The **Status** column shows all media as **Online**.
3. Check the box in the **Rec. 1** or **Rec. 2** column to specify the recording tracks to be recorded on the target selected.

6.2.4 Formatting storage media

All recordings on a storage medium can be deleted at any time. Check the recordings before deleting and back-up important sequences on the computer's hard drive.

1. Click a storage medium in the **Managed storage media** list to select it.
2. Click **Edit** below the list.
3. Click **Format** in the new window to delete all recordings in the storage medium.
4. Click **OK** to close the window.

6.2.5 Deactivating storage media

A storage medium in the **Managed storage media** list can be deactivated. It is then no longer used for recordings.

1. Click a storage medium in the **Managed storage media** list to select it.
2. Click **Remove** below the list. The storage medium is deactivated and removed from the list.

6.3 Recording Profiles

A recording profile contains the characteristics of the tracks that are used for recording. These characteristics can be defined for ten different profiles. The profiles can then be assigned to days or times of day on the **Recording Scheduler** page.

Each profile is color-coded. The names of the profiles can be changed on the **Recording Scheduler** page.

To configure a profile, click its tab to open its settings page.

- To copy the currently visible settings to other profiles, click **Copy Settings**. A window opens to select the target profiles for the copied settings.
- If you change a profile's settings, click **Set** to save.
- If necessary, click **Default** to return all settings to their factory defaults.

Stream profile settings

Select the encoder profile setting that is to be used with stream 1 and 2 when recording. This selection is independent of the selection for live stream transmission. (The properties of the encoder profiles are defined on the **Encoder Profile** page.)

Pre-position

Select the appropriate pre-position to record. Options are **Tour A**, **Tour B**, **Custom Tour**, and configured pre-positions.

Settings for selected recordings

Recording includes

You can specify whether, in addition to video data and metadata (for example alarms, VCA data and serial data) should also be recorded. Including metadata could make subsequent searches of recordings easier but it requires additional memory capacity.



Caution!

Without metadata, it is not possible to include video content analysis in recordings.

Select what is to be included in the recordings:

- **Audio:** If audio is not enabled, **Off** is shown. Click on **Off** and the page is redirected to the **Audio** section.
- **Metadata.**

Standard recording

Select the mode for standard recordings:

- **Continuous:** the recording proceeds continuously. If the maximum recording capacity is reached, older recordings are overwritten automatically.
- **Pre-alarm:** recording takes place in the pre-alarm time, during the alarm and during the post-alarm time only.
- **Off:** no automatic recording takes place.

Stream

Select the stream to be used for standard recordings:

- **Stream 1**
- **Stream 2**
- **I-frames only**

Alarm recording

Select a period for the **Pre-alarm time** from the list box.

Select a period for the **Post-alarm time** from the list box.

Alarm stream

Select the stream to be used for alarm recordings:

- **Stream 1**
- **Stream 2**
- **I-frames only**

Check the **encoding interval and bit rates from profile:** box and select an encoder profile to set the associated encoding interval for alarm recording.

Check the **Export to account** box to send standard H.264 or H.265 files to the target whose address is displayed.

If the target has not yet been defined, click **Configure accounts** to jump to the **Accounts** page where the server information can be entered.

Alarm triggers *

Select the alarm type that is to trigger an alarm recording:

- **Alarm input**
- **Analysis alarm**
- **Video loss**

Select the **Virtual alarm** sensors that are to trigger a recording, via RCP+ commands or alarm scripts, for example.

6.4 Maximum Retention Time

Recordings are overwritten when the retention time entered here has expired.

- ▶ Enter the required retention time in days for each recording track.

Make sure that the retention time does not exceed the available recording capacity.

6.5 Recording Scheduler

The recording scheduler allows you to link the created recording profiles with the days and times at which the camera's images are to be recorded in the event of an alarm.

You can link any number of 15-minute intervals with the recording profiles for each day of the week. Moving the mouse cursor over the table displays the time below it. This aids orientation. In addition to the normal weekdays, you can define holidays that are not in the standard weekly schedule on which recordings are to apply. This allows you to apply a schedule for Sundays to other days with dates that fall on varying weekdays.

Weekdays

Assign as many time periods (in 15-minute intervals) as needed for any day of the week. Move the mouse cursor over the table - the time is displayed.

1. Click the profile to be assigned in the **Time periods** box.
2. Click a field in the table and, while holding down the left mouse button, drag the cursor across all of the fields to be assigned to the selected profile.
3. Click the **No recordings** profile in the **Time periods** box to deselect the intervals.
4. Click **Select All** to select all of the intervals to be assigned to the selected profile.
5. Click **Clear All** to deselect all of the intervals.
6. When finished, click **Set** to save the settings to the device.

Holidays

You can define holidays that are not in the standard weekly schedule on which recordings are to apply. This allows you to apply a schedule for Sundays to other days with dates that fall on varying weekdays.

1. Click the **Holidays** tab. Any days that have already been selected will be shown in the table.
2. Click the **Add** button. A new window will open.
3. Select the desired date from the calendar. You can select several consecutive calendar days by holding down the mouse button. These will later be displayed as a single entry in the table.
4. Click **OK** to accept the selection. The window will close.
5. Assign the individual holidays to the recording profiles, as described above.

Deleting Holidays

You can delete holidays you have defined yourself at any time.

1. Click the **Delete** button. A new window will open.

2. Click the date you wish to delete.
3. Click **OK**. The item will be deleted from the table and the window will close.
4. The process must be repeated for deleting additional days.

Time periods

You can change the names of the recording profiles.

1. Click a profile and then the **Rename** button.
2. Enter your chosen name and then click the **Rename** button again.

Activating the Recording

After completing configuration you must activate the recording scheduler and start the recording. Once recording is underway, the **Recording Profiles** and **Recording Scheduler** pages are deactivated and the configuration cannot be modified.

You can stop the recording activity at any time and modify the settings.

1. Click the **Start** button to activate the recording scheduler.
2. Click the **Stop** button to deactivate the recording scheduler. Running recordings are interrupted and the configuration can be changed.

Recording status

The graphic indicates the recording activity of the camera. You will see an animated graphic while recording is taking place.

6.6 Recording Status

Details of the recording status are displayed here for information. These settings cannot be changed.

6.7 Recording Statistics

Recording

Identifies the current recording profile (1 or 2).

Zoom

Identifies the current zoom factor of the camera (1x, 2x, 4x, or 8x).

Averaging period

Select the appropriate averaging period as a means of stabilizing the long term bit rate.

6.8 Image Posting

JPEG

Image size

Select the size of the JPEG images that are to be sent from the camera. JPEG resolution corresponds to the highest setting from the two data streams.

Options are:

- 256 x 144
- 512 x 288
- 768 x 432
- 1280 x 720
- 1536 x 864
- 1920 x 1080
- 2560 x 1440
- **Resource based**

The default option is 256 x 144.

File name

Select how file names are created for the individual images that are transmitted.

- **Overwrite:** The same file name is always used and any existing file will be overwritten by the current file.
- **Increment:** A number from 000 to 255 is added to the file name and automatically incremented by 1. When it reaches 255, it starts again from 000.
- **Date/time suffix:** The date and time are automatically added to the file name. When setting this parameter, make sure that the date and time of the device are always set correctly. For example, the file snap011005_114530.jpg was stored on October 1, 2005 at 11:45 and 30 seconds.

VCA overlays

To include VCA overlays in the email, select this check box.

Posting interval

Enter the interval in seconds at which the images are sent to an FTP server. Enter zero for no images to be sent.

The following field may or may not appear, depending on your camera:

Target

Select the target account for JPEG posting.

**Notice!**

You must configure an account in order to have functionality for **Image Posting**. Click on **Configure accounts** to do so.

Target

Select the target account to which to save images.

7

Alarm

7.1

Alarm Connections

You can select how the camera responds to an alarm. In the event of an alarm, the unit can automatically connect to a pre-defined IP address. You can enter up to ten IP addresses to which the camera will connect in sequence in the event of an alarm, until a connection is made.

Connect on alarm

Select **On** so that the camera automatically connects to a predefined IP address in the event of an alarm.

By setting **Follows input 1***, the unit maintains the connection that has been automatically established for as long as an alarm exists on alarm input 1.



Notice!

In the default setting, Stream 2 is transmitted for alarm connections. Consider this when assigning the profile (see Encoder Profile).

Auto-connect

Select the **On** option to automatically re-establish a connection to one of the previously specified IP addresses after each reboot, after a connection breakdown or after a network failure.



Notice!

In the default setting, Stream 2 is transmitted for automatic connections. Bear this fact in mind when assigning the profile (see Encoder Profile).

Number of destination IP address

Specify the numbers of the IP addresses to be contacted in the event of an alarm. The unit contacts the remote stations one after the other in the numbered sequence until a connection is made.

Destination IP address

For each number, enter the corresponding IP address for the desired remote station.

Destination password

If the remote station is password protected, enter the password here.

Only ten passwords can be defined here. Define a general password if more than ten connections are required. The unit connects to all remote stations protected by the same general password. To define a general password:

1. Select 10 in the **Number of destination IP address** list box.
2. Enter 0.0.0.0 in the **Destination IP address** field.
3. Enter the password in the **Destination password** field.
4. Set the user password of all the remote stations to be accessed using this password.

Setting destination 10 to the IP-address 0.0.0.0 overrides its function as the tenth address to try.

Video transmission

If the unit is operated behind a firewall, select **TCP (HTTP port)** as the transfer protocol. For use in a local network, select **UDP**.

**Caution!**

Please note that in some circumstances, a larger bandwidth must be available on the network for additional video images in the event of an alarm, in case Multicast operation is not possible. To enable Multicast operation, select the **UDP** option for the **Video transmission** parameter here and on Network Access.

Stream

Select the number of the stream from the drop-down list.

Remote port

Depending on the network configuration, select a browser port here. The ports for HTTPS connections will be available only if the **On** option is selected in the **SSL encryption** parameter.

Video output

If you know which unit is being used as the receiver, you can select the analog video output to which the signal should be switched. If the destination unit is unknown, it is advisable to select the **First available** option. In this case, the image is placed on the first free video output. This is an output on which there is no signal. The connected monitor only displays images when an alarm is triggered. If you select a particular video output and a split image is set for this output on the receiver, you can also select from **Decoder** the decoder in the receiver that is to be used to display the alarm image.

**Notice!**

Refer to the destination unit documentation concerning image display options and available video outputs.

Decoder

If a split image is set for the selected video output, select a decoder to display the alarm image. The decoder selected determines the position in the split image.

SSL encryption

SSL encryption protects data used for establishing a connection, such as the password. By selecting **On**, only encrypted ports are available for the **Remote port** parameter. SSL encryption must be activated and configured on both sides of a connection.

The appropriate certificates must also have been uploaded. (Certificates can be uploaded on the **Maintenance** page.)

Configure and activate encryption for media data (such as video, metadata or audio when available) on the **Encryption** page (encryption is only available if the appropriate license is installed).

Audio

Select **On** to activate audio alarms.

7.2

Video Content Analysis (VCA)

Note: This section of the manual provides an overview of the fields and the options for each field on the page **VCA**. This section is not a complete tutorial of setting up **VCA**. For more information, refer to the separate manual *Video Content Analysis (VCA)*, available on the product page for Intelligent Video Analytics. Access the product page on the online product catalog through the appropriate link from <https://www.boschsecurity.com/xc/en/product-catalog/>.

Note: If there is not enough computing power, priority is given to live images and recordings. This can lead to impairment of the VCA system. Observe the processor load and optimize the encoder settings or the VCA settings if necessary, or turn off VCA completely.

Help for VCA settings

A separate Help file provides information about configuring for the VCA settings.

Note: Full VCA configuration and Help is only available on the web browser when MPEG ActiveX software from Bosch is installed on your computer. MPEG ActiveX software is available from the Bosch Security Systems DownloadStore (<https://downloadstore.boschsecurity.com/>)

To open the VCA Help in the web browser:

1. Select **Configuration > Alarm >> VCA**
2. Click **Configuration**. The VCA window appears.
3. Ensure that the VCA window is on top and active. If not, click the window.
4. Press **F1**.

VCA configuration

Select one of the profiles here to activate it or edit it.

You can rename the profile.

1. To rename the file, click the icon to the right of the list field and enter the new profile name in the field.
2. Click the icon again. The new profile name is saved.

Do not use any special characters, for example **&**, in the name. Special characters are not supported by the system's internal management.

The default option is Profile #1.

If you select the option Silent VCA, then the system creates metadata to facilitate searches of recordings but no alarm is triggered. You cannot change any parameters for this configuration. If you want to turn off VCA, then select Off.

If necessary, click the button **Default** to return all settings to their default values. A dialog box appears with the message, "**Configuration of the video content analysis (VCA) will be reset to factory defaults. The changes will be lost. Click 'OK' to continue.**" Click **OK** to acknowledge the message, or click **Cancel**.

Scenario

Scenarios are applications with pre-defined settings that are adapted to specific use cases. All relevant settings, from tasks to metadata, are set automatically by the system.

The following scenarios are available:

- Intrusion (one field)
- Intrusion (two fields)
- People counting
- Traffic incidents
- Traffic wrong way



Notice!

A camera calibration is required for all scenarios.

Using the scenarios will reset the VCA configuration to the scenario defaults.

All values (**Metadata Generation** and **Tasks**) can be edited after activating the scenario defaults.

Delete tasks that do not fit your use cases.

Alarm status

The alarm status is displayed here for information purposes. This means you can check the effects of your settings immediately.

Tamper detection

Detect tampering of cameras and video cables by means of various options. Run a series of tests at different times of the day and night to ensure that the video sensor is operating as intended.

Sensitivity and **Trigger delay [s]** can only be changed if **Reference check** is selected.

Reference check

Save a reference image that can be continuously compared with the current video image. If the current video image in the marked areas differs from the reference image, an alarm is triggered. This detects tampering that would otherwise not be detected, for example, if the camera is turned.

1. Click **Reference** to save the currently visible video image as a reference.
2. Click **Add mask** and select the areas in the reference image that are to be ignored. Click **Set** to apply.
3. Check the box **Reference check** to activate the on-going check. The stored reference image is displayed in black and white below the current video image.
4. Select the **Disappearing edges** or **Appearing edges** option to specify the reference check once again.

Sensitivity

The basic sensitivity of the tamper detection can be adjusted for the environmental conditions to which the camera is subject. The algorithm reacts to the differences between the reference image and the current video image. The darker the observation area, the higher the value that must be selected.

Trigger delay [s]

Set delayed alarm triggering here. The alarm is only triggered after a set time interval in seconds has elapsed and then only if the triggering condition still exists. If the original condition has been restored before this time interval elapses, the alarm is not triggered. This avoids false alarms triggered by short-term changes, for example, cleaning activities in the direct field of vision of the camera.

Disappearing edges

The area selected in the reference image should contain a prominent structure. If this structure is concealed or moved, the reference check triggers an alarm. If the selected area is too homogenous, so that concealing and moving the structure would not trigger an alarm, then an alarm is triggered immediately to indicate the inadequate reference image.

Appearing edges

Select this option if the selected area of the reference image includes a largely homogenous surface. If structures appear in this area, then an alarm is triggered.

Global change

Activate this function if the global change, as set with the Global change slide control, should trigger an alarm.

Global change (slider)

Set how large the global change in the video image must be for an alarm to be triggered. This setting is independent of the sensor fields selected under **Mask...** Set a high value if fewer sensor fields need to change to trigger an alarm. With a low value, it is necessary for changes

to occur simultaneously in a large number of sensor fields to trigger an alarm. This option allows detection, independently of motion alarms, manipulation of the orientation or location of a camera resulting from turning the camera mount bracket, for example.

Scene too bright

Activate this function if tampering associated with exposure to extreme light (for instance, shining a flashlight directly on the lens) should trigger an alarm.

Use the slider to set the threshold of the alarm trigger.

Scene too dark

Activate this function if tampering associated with covering the lens (for instance, by spraying paint on it) should trigger an alarm.

Use the slider to set the threshold of the alarm trigger.

7.3 Audio Alarm

The camera can create alarms on the basis of audio signals. You can configure signal strengths and frequency ranges in such a way that false alarms, for example due to machine noise or background noise, are avoided.



Notice!

First set up normal audio transmission before you configure the audio alarm here (see Audio).

Audio alarm

Select **On** if you want the device to generate audio alarms.

Do not use any special characters, for example **&**, in the name. Special characters are not supported by the system's internal management.

Signal Ranges

You can exclude particular signal ranges in order to avoid false alarms. For this reason the total signal is divided into 13 tonal ranges (mel scale). Check or uncheck the boxes below the graphic to include or exclude individual ranges.

Threshold

Set up the threshold on the basis of the signal visible in the graphic. You can set the threshold using the slide control or, alternately, you can move the white line directly in the graphic using the mouse.

Sensitivity

You can use this setting to adapt the sensitivity to the sound environment. You can effectively suppress individual signal peaks. A high value represents a high level of sensitivity.

7.4 Alarm E-Mail

As an alternative to automatic connecting, alarm states can also be documented by e-mail. In this way it is possible to notify a recipient who does not have a video receiver. In this case, the camera automatically sends an e-mail to a previously defined e-mail address.

Send alarm e-mail

Select **On** if you want the unit to automatically send an alarm e-mail in the event of an alarm.

Mail server IP address

Enter the IP address of a mail server that operates on the SMTP standard (Simple Mail Transfer Protocol). Outgoing e-mails are sent to the mail server via the address you entered. Otherwise leave the box blank (**0.0.0.0**).

SMTP port

Select the appropriate SMTP port.

SMTP user name

Enter a registered user name for the chosen mailserver here.

SMTP password

Enter the required password for the registered user name here.

Format

You can select the data format of the alarm message.

- **Standard (with JPEG)** E-mail with attached JPEG image file.
- **SMS** E-mail in SMS format to an e-mail-to-SMS gateway (for example to send an alarm by cellphone) without an image attachment.

**Caution!**

When a cellphone is used as the receiver, make sure to activate the e-mail or SMS function, depending on the format, so that these messages can be received.

You can obtain information on operating your cellphone from your cellphone provider.

Image size

Select the size of the JPEG images that are to be sent from the camera.

Options are:

- 256 x 144
- 512 x 288
- 768 x 432
- 1280 x 720
- 1536 x 864
- 1920 x 1080
- 2560 x 1440
- **Resource based**

Attach JPEG from camera

Click the checkbox to specify that JPEG images are sent from the camera. An enabled video input is indicated by a check mark.

VCA overlays

Select the **VCA overlays** check box, to place the outline of the object that triggered an alarm into the camera image sent as snapshot via e-mail.

Destination address

Enter the e-mail address for alarm e-mails here. The maximum address length is 49 characters.

Sender address

Enter a unique name for the e-mail sender, for example the location of the device. This will make it easier to identify the origin of the e-mail.

Note: The name must include at least two character groups separated by a blank (for example, Parking Garage) in order for the system to generate an email from that name, as in “From Parking Garage”. Text with only one group of characters (for example, Lobby) will not generate an email.

Test e-mail

You can test the e-mail function by clicking the **Send Now** button. An alarm e-mail is immediately created and sent.

7.5 Alarm Inputs

Active

Configure the alarm triggers for the unit.

Select **N.C.** (Normally Closed) if the alarm is to be triggered by opening the contact.

Select **N.O.** (Normally Open) if the alarm is to be triggered by closing the contact.

Select **N.C.S.** (Normally Closed Supervised) if the alarm is to be triggered by opening the contact.

Select **N.O.S.** (Normally Open Supervised) if the alarm is to be triggered by closing the contact.

A supervised alarm transmits both the alarm condition and the tamper condition. Depending on how the alarm is configured, a short or a break in the alarm's circuit can trigger the tamper signal.

(NCS and NOS contacts are only present on some cameras)

Name

You can enter a name for each alarm input. If the **Live** functions are configured accordingly, this name is displayed below the icon for the alarm input. You can also use the name in the Forensic Search program function as a filter option for quick search in recordings. Enter a unique and clear name here.



Caution!

Do not use any special characters, for example **&**, in the name.

Special characters are not supported by the system's internal management.

Note: This name appears in the **Digital I/O** section of the **Live** page.

Action

Select a type of action to be performed when an alarm input occurs:

– **None**

– **Monochrome**

This switches the camera to the monochrome mode.

– **Switch mode**

When this is selected, you can select the **Scene Mode** to be used for the active and inactive period of the alarm.

(only available on some cameras)

7.6 Alarm Outputs

Idle state

Select **Open** if you want the relay to operate as an NO contact, or select **Closed** if the relay is to operate as an NC contact.

Operating mode

Select an operating mode for the relay.

For example, if you want an alarm-activated lamp to stay on after the alarm ends, select

Bistable. If you wish an alarm-activated siren to sound for ten seconds, for example, select **10 s**.

Output name

Enter a name for the alarm output.

This name appears on the **Live** page.

Note: This name appears in the **Digital I/O** section of the **Live** page.

Toggle

Click the button to test the relay / output connection.

7.7

Alarm Task Editor

Editing scripts on this page overwrites all settings and entries on the other alarm pages. This procedure cannot be reversed.

To edit this page, you should have programming knowledge and be familiar with the information in the Alarm Task Script Language document and the English language.

As an alternative to the alarm settings on the various alarm pages, enter the desired alarm functions in script form here. This will overwrite all settings and entries on the other alarm pages.

1. Click **Examples** under the Alarm Task Editor field to see some script examples. A new window opens.
2. Enter new scripts in the Alarm Task Editor field or change existing scripts in line with your requirements.
3. When finished, click **Set** to transmit the scripts to the device. If the transfer was successful, the message **Script successfully parsed.** is displayed over the text field. If it was not successful, an error message is displayed with further information.

7.8

Alarm Rules

An alarm rule can define which input(s) activate which output(s). Basically, an alarm rule allows you to customize the camera to respond automatically to different alarm inputs. To configure an alarm rule, specify one input from a physical connection, from a motion detection trigger, or from a connection to the camera's LIVE page. The physical input connection can be activated by dry contact devices such as pressure pads, door contacts, and similar devices.

Next, specify up to two (2) rule outputs, or the camera's response to the input. Outputs include a physical alarm output, an AUX command, or a preposition scene.

This alarm alerts users if anyone tries to open the housing of the device.

(Refer to the "Operating the camera with AUX commands" section of the manual for a list of all AUX commands for your camera.)

Click the checkbox **Enabled** to activate the alarm.

Click Set to save. The camera's system activates the alarm rules.

8 Network

The settings on these pages are used to integrate the device into a network. Some changes only take effect after a reboot. In this case **Set** changes to **Set and Reboot**.

1. Make the desired changes.
2. Click **Set and Reboot**.

The device is rebooted and the changed settings are activated.

8.1 Network Services

This page shows an overview of all available network services. Use the checkbox to activate or deactivate a network service. Click on the settings symbol next to the network service to go to the settings page for this network service.

8.2 Network Access

The settings on this page are used to integrate the camera into an existing network.

Automatic IPv4 assignment

If the network has a **Automatic assignment (DHCP)** server for the dynamic assignment of IP addresses, select **On** to accept automatically the **Automatic assignment (DHCP)-assigned IP address**.

For certain applications, the **Automatic assignment (DHCP)** server must support the fixed assignment between **IP address** and **MAC address**, and must be set up appropriately so that, once an IP address is assigned, it is retained each time the system is rebooted.

Ethernet

The Ethernet options are defined in this section.

IP V4 address

IP address

Enter the desired IP address for the camera in this field. The IP address must be valid for the network.

Automatic address

If you have set up your network to use automatically assigned IP addresses, the assigned address is displayed here for information.

Subnet mask

Enter the appropriate subnet mask for the selected IP address here.

Gateway address

If you want the unit to establish a connection to a remote location in a different subnet, enter the IP address of the gateway here. Otherwise leave the box blank (**0.0.0.0**).

IP V6 address

IP address

Enter the desired IP address for the camera in this field. The IP address must be valid for the network. A typical IPv6 address may resemble the following example:

2001:db8::52:1:1

Consult the network administrator for valid IPv6 address construction.

Automatic address

If you have set up your network to use automatically assigned IP addresses, the assigned address is displayed here for information.

Prefix length

A typical IPv6 node address consists of a prefix and an interface identifier (total 128 bits). The prefix is the part of the address where the bits have fixed values or are the bits that define a subnet.

Gateway address

If you want the unit to establish a connection to a remote location in a different subnet, enter the IP address of the gateway here. Otherwise leave the box blank (**0.0.0.0**).

DNS server address 1 / DNS server address 2

The camera is easier to access if the unit is listed on a DNS server. If you wish, for example, to establish an Internet connection to the camera, it is sufficient to enter the name given to the unit on the DNS server as a URL in the browser. Enter the IP address of the DNS server here. Servers are supported for secure and dynamic DNS.

Video transmission

If the unit is operated behind a firewall, select **TCP (HTTP port)** as the transfer protocol. For use in a local network, select **UDP**.

**Notice!**

Multicast operation is only possible with the UDP protocol. The TCP protocol does not support multicast connections. The MTU value in UDP mode is 1,514 bytes.

HTTP browser port

Select a different HTTP browser port from the list if required. The default HTTP port is 80. If you want to allow only secure connections via HTTPS, you must deactivate the HTTP port. In this case, select **Off**.

HTTPS browser port

If you wish to allow browser access on the network via a secure connection, select an HTTPS browser port from the list if necessary. The default HTTPS port is 443. Select the **Off** option to deactivate HTTPS ports; only unsecured connections will now be possible.

The camera uses the TLS 1.0 encryption protocol. You may have to activate this protocol via your browser configuration. You must also activate the protocol for the Java applications (via the Java control panel in the Windows control panel).

**Notice!**

If you want to allow only secure connections with SSL encryption, you must select the **Off** option for each of the parameters **HTTP browser port**, **RCP+ port 1756** and **Telnet support**. This deactivates all unsecured connections. Connections will then only be possible via the HTTPS port.

You can activate and configure encryption of the media data (video and metadata) on the **Encryption** page (see Encryption).

Minimum TLS version

Select the version for minimum Transport Layer Security (TLS).

Allow HTTP basic authentication

Select **On** if you want to allow HTTP basic authentication. This is a less secure authentication option where passwords are transmitted in clear text. This option should only be used if the network and system are otherwise secured.

HSTS

Select this option to use the web security policy HTTP Strict Transport Security (HSTS) to provide secure connections.

RCP+ port 1756

To exchange connection data, you can activate the unsecured RCP+ port 1756. If you want connection data to be transmitted only when encrypted, select the **Off** option to deactivate the port.

Discovery port (0 = Off)

Enter the number of the port that you want to discover.

To deactivate the port, enter 0.

Network MSS (Byte)

You can set the maximum segment size for the IP packet's user data. This gives you the option to adjust the size of the data packets to the network environment and to optimize data transmission. Please comply with the MTU value of 1,514 bytes in UDP mode.

Network MTU [Byte]

Specify a maximum value in bytes for the package size (including IP header) to optimize data transmission.

8.3

Advanced

The settings on this page are used to implement advanced settings for the network.

802.1x**Authentication**

If a RADIUS server is employed in the network for managing access rights, authentication must be activated here to allow communication with the unit. The RADIUS server must also contain the corresponding data.

To configure the unit, you must connect the camera directly to a computer using a network cable. This is because communication via the network is not enabled until the **Identity** and **Password** parameters have been set and successfully authenticated.

Identity

Enter the name that the RADIUS server is to use for identifying the camera.

Password

Enter the password that is stored in the RADIUS server.

Password [EAP-MD5]

Enter the password that is stored in the RADIUS server.

Certificates [EAP-TLS]

If any certificates are already uploaded at the client level or at the server level, they show here.

Click **Configure**.

Syslog**Server IP address**

Enter the appropriate IP address of the server.

Server port (0 = Off)

Enter the number of the server port.

Protocol

Select the appropriate protocol: **UDP**, **TCP**, or **TLS**.

8.4 Network Management

SNMP

The camera supports two versions of Simple Network Management Protocol (SNMP) for managing and monitoring network components, and can send SNMP messages (traps) to IP addresses. The unit supports SNMP MIB II in the unified code.

Select either of the options that follow for the **SNMP** parameter:

- **SNMP v1 legacy**
- **SNMP v3**

If you select either of the SNMP version, but do not enter an SNMP host address, the camera does not send messages (traps) automatically, but only replies to SNMP requests.

Select **Off** to deactivate the SNMP function.

1. SNMP host address / 2. SNMP host address

If you wish to send SNMP traps automatically, enter the IP addresses of one or two required target units here.

The three (3) subchapters that follow identify the fields that appear depending on the option that you select in the field **SNMP**.

8.4.1 Quality of Service

The priority of the different data channels can be set by defining the DiffServ Code Point (DSCP). Enter a number between 0 and 252 as a multiple of four. For alarm video you can set a higher priority than for regular video and you can define a Post Alarm Time over which this priority is maintained.

8.5 Multicast

The camera can enable multiple receivers to receive the video signal simultaneously. The stream is either duplicated and then distributed to multiple receivers (Multi-unicast), or it is sent as a single stream to the network, where it is simultaneously distributed to multiple receivers in a defined group (Multicast).

Multicast operation requires a multicast-enabled network that uses UDP and the Internet Group Management protocol (IGMP V2). The network must support group IP addresses. Other group management protocols are not supported. The TCP protocol does not support multicast connections.

A special IP address from 225.0.0.0 to 239.255.255.255 (class D address) must be configured for multicast operation in a multicast-enabled network. The multicast address can be the same for multiple streams, however, it is necessary to use a different port in each case.

The settings must be made individually for each stream. Enter a dedicated multicast address and port for each stream. Switch between the streams by clicking the appropriate tabs.

Enable

Enable simultaneous data reception on receivers that need to activate the multicast function. To do this, check the box and enter the multicast address.

Multicast Address

Enter a valid multicast address to be operated in multicast mode (duplication of the data stream in the network).

With a 0.0.0.0 setting, the encoder for the stream operates in multi-unicast mode (copying of data stream in device). The camera supports multi-unicast connections for up to five simultaneously connected receivers.

Duplication of data places a heavy demand on the CPU and can lead to impairment of the image quality under certain circumstances.

Port

Enter the port address for the stream here.

Streaming

Click the checkbox to activate multicast streaming mode. An activated stream is marked with a check. (Streaming is typically not required for standard multicast operation.)

Multicast packet TTL

You can enter a value to specify how long the multicast data packets are active on the network. This value must be greater than one if multicast is to be run via a router.

IGMP version

You can define the multicast IGMP version to comply with the device.
Click **Set** to apply the changes.

8.6

IPv4 Filter

Use this setting to configure a filter that allows or blocks network traffic that matches a specified address or protocol.

IP Address 1 / 2

Enter the IPv4 address that you want to allow or block

Mask 1 / 2

Enter the subnet mask for the appropriate IPv4 address.

9 Service

9.1 Maintenance

Update server

The address of the update server appears in the address box.

1. Click **Check** to make a connection to this server.
2. Select the appropriate version for your camera to download the firmware from the server.

Firmware

The camera functions and parameters can be updated by uploading new firmware. To do this, the latest firmware package is transferred to the device via the network. The firmware is installed there automatically. Thus, a camera can be serviced and updated remotely without requiring a technician to make changes to the device on site. The latest firmware can be obtained from your customer service center or from the download area.



Notice!

Potential loss of data

Bosch recommends that you save all device configurations, including IVA and calibration, on your network before starting a firmware update.



Notice!

Before starting a firmware update, make sure to select the correct upload file.

Do not interrupt the firmware installation. Even changing to another page or closing the browser window leads to interruption.

Uploading the wrong files or interrupting the upload can result in the device no longer being addressable, requiring it to be replaced.



Caution!

Do not remove power to the unit during a factory default or a firmware update. Wait at least two minutes for the default process to complete. If the unit appears to be "frozen" after two minutes, then reboot the unit. Refer to *Troubleshooting, page 61* for more details.

Progress

The progress bar displays the progress of the firmware upload.

Note: Once the progress bar reaches 100%, a reset page may appear. If this page appears, allow the reset page to complete its action.

Upload history

Click **Show** to view the firmware upload history.

Configuration

Click **Browse...** to navigate to the required firmware file (*.fw).

Note: Ensure that the file to be loaded comes from the same unit type as the unit that you want to configure.

Click **Upload** to begin transferring the file to the unit. Click OK to the warning message to continue the firmware upload, or Cancel to stop the upload.

Click **Download** to save the camera settings to a file to upload to the same camera or to a similar camera in the future.

Maintenance log

You can download an internal maintenance log from the unit to send it to Customer Service for support purposes. Click **Download** and select a storage location for the file.

9.2 Licenses

This window is for the activation of additional functions by entering activation codes. An overview of installed licenses is shown. The installation code of the unit is also displayed here.

9.3 Certificates

Add a certificate/file to the file list

Click **Add**.

In the Add certificate window choose either:

- **Upload certificate** to select a file that is already available:
 - Click **Browse** to navigate to the required file.
 - Click **Upload**.
- **Generate signing request** for a signing authority to create a new certificate:
 - Fill in all the required fields and click **Generate**.
- **Generate certificate** to create a new self-signed certificate:
 - Fill in all the required fields and click **Generate**.

Delete a certificate from the file list

Click the trashcan icon to the right of the certificate. The Delete file window appears. To confirm deletion, click OK. To cancel deletion, click Cancel.

Note: You can only delete certificates that you have added; you cannot delete the default certificate.

9.4 Logging

Event Logging

Current log level

Select the level of event for which to display log entries or to log.

Number of displayed entries

Select the number of entries to display.

Software Sealing

Enable software sealing

Select this check box to enable software protection that prevents users from adjusting camera settings. This function also protects the camera from unauthorized access.

Debug Logging

Retrieves detailed information of the active logs.

Diagnostics

Retrieves diagnostics information.

Reload

Reloads the displayed entries.

Download log

Save a copy of the entries from the device to a computer.

To save the entries:

1. Click **Download log**; a dialog box appears.

Enter a file name if required and save

9.5 Diagnostics

Accesses the Built-in Self Test (BIST). The BIST displays status **Passed** or **Failed** on the most recent homing event, not a counter. For the other items, a counter is maintained.

Click the button **Start self-test** to show the number of times that the camera:

- performed a homing event.
- failed to home properly.
- restarted.
- lost video.

Logs

This section updates automatically with the history of the camera and maintains a log of all events such as those listed below. Click the REFRESH button to reload log data.

9.6**System Overview**

This window is for information only and cannot be modified. Keep this information at hand when seeking technical support.

Select the text on this page with a mouse and copy it so that it can be pasted into an e-mail if required.

10 Operation via the browser

10.1 Live page

10.1.1 Connection

Stream 1

Select this option to display stream 1 of the camera.

Stream 2

Select this option to display stream 2 of the camera.

M-JPEG

Select this option to display the M-JPEG stream of the camera.

10.1.2 PTZ

When you use a browser to control the camera, the PTZ controls are HTML5 based.

Pan and tilt controls

- To tilt the camera up: Click and hold the up arrow.
- To tilt the camera down: Click and hold the down arrow.
- To pan the camera left: Click and hold the left arrow.
- To pan the camera right: Click and hold the right arrow.
- To pan and tilt the camera at the same time (variable pan/tilt): Click and drag the center area (that resembles a point stick or a trackball on a computer keyboard) around the PTZ control in the direction that you want to move the camera.

Zoom

Click the + button to zoom in.

Click the - button to zoom out.

A "snap to area" or "snap to zoom" function allows you to select a different area of the video image to which to zoom the camera.

Hold the **Ctrl** key and use your mouse to draw a box/rectangle over the video to define the area to which to zoom. When you release the **Ctrl** key, the camera zooms to the defined position.

Iris

Click  (**Iris close**) to close the iris.

Click  (**Iris open**) to open the iris.

Note: When you close or open the iris, **ALC level** will be adjusted simultaneously.

Focus

Click  to focus near.

Click  to focus far.

10.1.3 Pre-positions

The camera displays **Pre-position 1** through **Pre-position 6**. Select the appropriate pre-position to view the video image for that pre-position/scene. In the lower left of the video image, the OSD displays the Camera number (title), the Pre-position number, and the Pre-position number stored.

Below the list of pre-positions/scenes is a drop-down list showing the stored pre-positions/scenes.



Select the appropriate pre-position (1 through 6). Click  to store the pre-position.

Note: If the pre-position is already stored, a dialog box displays the message, “**Overwrite current pre-position?**” Click **OK** to overwrite, or click **Cancel** to cancel the operation.



Click  to display the selected pre-position in the video image.

10.1.4

AUX Control

With the tab **AUX Control** you can enter pre-programmed keyboard control commands. These commands are composed of a command number plus the appropriate function key (**Show pre-position**, **Set pre-position**, **AUX on**, or **AUX off**). A valid combination either issues a command to the device or displays an on-screen menu.

(Refer to the “Operating the camera with AUX commands” section of the manual for a list of all AUX commands for your camera.)

Show pre-position

Click this button to display a pre-position.

Set pre-position

Click this button to set a pre-position.

AUX on

Click this button to activate an AUX command.

AUX off

Click this button to deactivate an AUX command.

10.1.5

Digital I/O

(only for cameras with alarm connections)

Depending on the configuration of the unit, the alarm input and the output are displayed next to the image. Expand the Digital I/O group if necessary.

The alarm symbol is for information and indicates the status of an alarm input:

- The symbol lights when the input alarm is active.

The alarm output allows the operation of an external device (for example, a light or a door opener).

- To activate the output, click the checkmark symbol.
 - The symbol lights when the output is activated.

Input 1

This parameter identifies the first alarm input.

Input 2

This parameter identifies the second alarm input.

Output 1

Click the checkmark icon to enable the output. The checkmark becomes green.

Note: You can change the name of an alarm input in **Configuration > Interfaces > Alarm Inputs > Input 1** (or **Input 2**) > **Name**.

You can change the name of an alarm output in **Configuration > Interfaces > Alarm Outputs > Output name**.

10.1.6 Special Functions

Tour A / Tour B

Click one of these buttons to start the continuous playback of a recorded (guard) tour. A recorded tour saves all manual camera movements made during the recording, including its rate of pan, tilt and zoom speeds, and other lens setting changes. To stop a tour, click a directional control in the View Control tab.

Find home

Click this button to trigger the camera to seek its home position. The OSD displays the message, "OSD: Finding Home Position."

Focus

Click this button to activate the Auto Focus One Push mode on the camera. The OSD displays the message, "Auto Focus: ONE PUSH."

Night mode

Click this button to activate/deactivate night mode for the camera. After a few seconds, the camera switches modes.

Note: This function is only available for IR models.

Note: This function is only available for IR models.

Custom tour

Click this button to view (in continuous playback) a custom tour that was previously configured.



To stop a tour, click a directional control in the PTZ section of the page.



10.1.7 Recording status

The hard drive icon  below the live camera image changes during an automatic recording. The icon lights up and displays a moving graphic to indicate a running recording. If no recording is taking place, a static icon is displayed.

10.1.8 Date and Time

Date/Time (unlabeled)

The unlabeled date and time ticker appears above the row of icons (including  

 ) that is below the lower-left corner of the live video image.

10.1.9 Full-screen video

Click the full-screen icon  to view the selected stream in full-screen mode; press **Esc** on the keyboard to return to the normal viewing window.

10.1.10 Saving snapshots

Individual images from the displayed live video stream can be saved locally in JPEG format on the computer's hard drive. The storage location depends on the configuration of the camera.

- Click the photo camera icon  to save a single image.

10.1.11 Recording live video

Video sequences from the displayed live video stream can be saved locally on the computer's hard drive. The sequences are recorded at the resolution specified in the encoder configuration. The storage location depends on the configuration of the camera.



1. Click the recording icon  to record video sequences.
 - Saving begins immediately. The red dot on the icon indicates that a recording is in progress.
2. Click the recording icon again to stop recording.

10.1.12 Video Security App

Start Video Security app



To start the Video Security app, click .

10.1.13 Show latest event



Click the Show latest event icon  to watch the last recorded important event. The **Playback** page opens.

10.1.14 Audio communication

Audio can be sent and received via the **Live** page if the unit and the computer support audio.

1. Press and hold the F12 key on the keyboard to send an audio signal to the unit.
2. Release the key to stop sending audio.

All connected users receive audio signals sent from the unit but only the user who first pressed the F12 key can send audio signals; others must wait for the first user to release the key.

10.1.15 Storage, CPU and network status

When you access the unit with a browser, the icons in the list that follows are at the top right corner of the window:



-  CPU load icon
-  Network load icon

The information from the icons can help with solving problems with the unit or with fine-tuning the unit.



Hover over the CPU load icon  to see the CPU load. If the CPU load is too high, change the VCA settings.

Hover over the Network load icon to see the network load. If the network load is too high, change the encoder profile to reduce the bitrate.

10.1.16 Status icons

Various overlays in the video image provide important status information. The overlays provide the following information:



Decoding error

The frame might show artifacts due to decoding errors.

**Alarm flag**

Indicates that an alarm has occurred.

**Communication error**

A communication error, such as a connection failure to the storage medium, a protocol violation or a timeout, is indicated by this icon.

**Gap**

Indicates a gap in the recorded video.

**Watermark valid**

The watermark set on the media item is valid. The color of the check mark changes according to the video authentication method that has been selected.

**Watermark invalid**

Indicates that the watermark is not valid.

**Motion alarm**

Indicates that a motion alarm has occurred.

**Storage discovery**

Indicates that recorded video is being retrieved.

10.2

Playback



Click **Playback** in the application bar to view, search or export recordings. This link is only visible when a direct iSCSI or memory card is configured for recording (with Video Recording Manager (VRM) recording this option is not active).

On the left side of the screen, there are four groups:

- **Connection**
- **Search**
- **Export**
- **Track list**

10.2.1

Selecting the recording stream

On the left side of the browser, expand the **Connection** group if necessary.

To view a recording stream:

1. Click the **Recording** drop-down arrow to see the options.
2. Select recording stream 1 or 2.

10.2.2

Searching for recorded video

On the left side of the browser, expand the **Search** group if necessary.

1. To limit the search to a particular time range, enter the date and times for the start and stop points.
2. Select an option from the drop-down box to define a search parameter.
3. Click **Search**.
4. The results are shown.
5. Click a result to play it back.

6. Click **Back** to define a new search.

10.2.3 Exporting recorded video

On the left side of the browser, expand the **Export** group if necessary.

1. Select a track in the track list or in the search results.
2. The start and stop date and time are filled-in for the selected track. If required, change the times.
3. In the **Time lapse** drop-down box, select the original or a condensed speed.
4. In the **Location** drop-down box, select a target.
5. Click **Export** to save the video track.

Note:

The target server address is set on the **Network / Accounts** page.

10.2.4 Track list

The **Track list** shows all the available recordings.

10.2.5 Controlling playback

The time bar below the video image allows quick orientation. The time interval associated with the sequence is displayed in the bar in gray. Arrows indicate the position of the image currently being played back within the sequence.

The time bar offers various options for navigation in and between sequences.

- If required, click in the bar at the point in time at which the playback should begin.
- Change the time interval displayed by clicking the plus or minus icons or use the mouse scroll wheel. The display can span a range from six months to one minute.
- Click the alarm jump buttons to go from one alarm event to the next or to the previous one. Red bars indicate the points in time where alarms were triggered.

Controls

Control playback by means of the buttons below the video image.

The buttons have the following functions:

- Start/Pause playback
- Select the playback (forward or backward) speed using the speed regulator
- Step forward or backward frame-by-frame when paused (small arrows)

10.3 Dashboard

The **Dashboard** page is used to display detailed information about the device and is only visible in the application bar if the **Show 'Dashboard'** option is enabled by a service-level user in the **Configuration > Web Interface > Appearance** page.

The **Dashboard** page shows information on 4 topics:

- **Device status**
- **Recording status**
- **Connection Status**
- **Services**

You can also download a .JSON file with information about the device:

1. Click the **Export** button at the bottom of the page
2. Select a location in your hard drive to store the file

11

AUX Commands

AUX	Function	Command	Notes
1	On/Off	Auto pan without limits (Continuous)	
2	On/Off	Auto pan between limits	
7	On/Off	Run Custom Pre-Position Tour	
8	On/Off	Run Pre-Position Tour	
18	On/Off	Auto pivot Enable	
20	On/Off	Backlight compensation (BLC)	
50	On/Off	Playback A (Continuous)	
51	On/Off	Playback A, single	
52	On/Off	Playback B (Continuous)	
53	On/Off	Playback B, single	
54	On/Off	IR mode	AUX on sets IR to Auto. AUX off sets IR mode off . Available for AUTODOME IP 5000i IR AUTODOME IP starlight 5100i IR only.
57	On/Off	Night mode IR Filter Toggle	
60	On/Off	On-Screen Display (OSD)	
67	On/Off	Focus adjust for external IR illuminators	
68	On/Off	White light illumination	AUTODOME IP starlight 5100i IR only
80	On/Off	Digital zoom lock	
88	On/Off	Proportional speed	
94	On/-	Recalibrate Azimuth Compass	
95	On/Off	Display Azimuth/Elevation	
96	On/Off	Display Compass Points	
100	On/Off	Record Tour A	
101	On/Off	Record Tour B	
104	On/Off	Wiper On/Wiper off (One shot)	AUTODOME IP starlight 5100i IR only
149	On/Off	Toggle Turbo mode	
700	On/Off	Adjust Proportional speed control	AUX on , entered repeatedly, cycles through increasing speeds Super slow , Slow , Medium , and Fast . AUX off decreases speeds through the same settings.
804	On/Off	Mask Calibration Procedure	

AUX	Function	Command	Notes
1-256	Set/-	Pre-position Programming	
1-256	-/Shot	Pre-position Recall	

12 Troubleshooting

Table of Troubleshooting Issues

The table below identifies issues that could occur with the camera, and how to resolve them.

Problem	Questions to Ask/Actions to Resolve the Problem
No camera control.	<ul style="list-style-type: none"> - Ensure that the LAN cable has good connection and is secured. - Refresh the browser and ensure that video is updated. - Cycle the camera's power off and on.
Video is rolling, noisy, or distorted.	<ul style="list-style-type: none"> - Check the integrity of all connectors and splices of the shielded Ethernet cable. If O.K., then: <ul style="list-style-type: none"> - Contact Bosch Technical Support.
Camera moves when attempting to move other cameras.	<ul style="list-style-type: none"> - Check that the camera's IP address is properly set. If camera's IP address is not set, then: <ul style="list-style-type: none"> - Use Configuration Manager to confirm that two cameras do not have the same IP address. If they do, change the address of one of the cameras.
No Network Connection.	<ul style="list-style-type: none"> - Check all network connections. - Ensure that the maximum distance between any two Ethernet connections is 100 m (328 ft) or less. If O.K., then: <ul style="list-style-type: none"> - If you are behind a firewall, ensure that the Video Transmission mode is set to UDP.
Camera does not operate at all, or does not operate as expected, after being subjected to extreme low temperatures (below -40 ° (-40 °F)).	<ul style="list-style-type: none"> - Allow the camera to warm up. The camera requires a 60-minute warm-up prior to PTZ operations. - If camera does not operate after this warm-up period, then reset the camera. In the URL line of your web browser, type "/reset" at the end of the IP address of the camera.
Nothing appears on the screen.	Are the power cord and line connection between the camera and monitor made properly?
The image on the screen is dim.	Is the lens dirty? If so, clean the lens with a soft, clean cloth.
The contrast on the screen is too weak.	Adjust the contrast feature of the monitor. Is the camera exposed to strong light? If so, change the camera position.
The image on the screen flickers.	Does the camera face directly into the sun or fluorescent lighting? If so, reposition camera.
The image on the screen is distorted.	Is the power frequency set properly in sync? If the power frequency is not set correctly, the line lock synchronization mode cannot be used. Set the synchronization mode to INT. (NTSC Model power frequency in LL mode: 60 Hz.)

Nothing appears on the screen.	Are the power cord and line connection between the camera and monitor made properly?
No video.	<ul style="list-style-type: none"> - Check that the mains power to the power supply is on. - For IP-enabled cameras: Check to see if you have a web page. <p>If you do, then try cycling the camera’s power off and on.</p> <p>If you do not, then you may have the wrong IP address. Use Configuration Manager to identify the correct IP address.</p> <p>If O.K., then:</p> <ul style="list-style-type: none"> - Check that there is 24 V output from the transformer. <p>If O.K., then:</p> <ul style="list-style-type: none"> - Check the integrity of all wires and mating connectors to the camera.
Picture is dark.	<ul style="list-style-type: none"> - Check that the Gain Control is set to High. <p>If O.K., then:</p> <ul style="list-style-type: none"> - Check that the Auto Iris Level is set to the appropriate level. <p>If O.K., then:</p> <ul style="list-style-type: none"> - Check that the maximum Ethernet cable distance has not been exceeded. <p>If O.K., then:</p> <ul style="list-style-type: none"> - Restore all camera settings.
Background is too bright to see subject.	Turn on backlight compensation.

Problem	Questions to Ask/Actions to Resolve the Problem
No camera control.	<ul style="list-style-type: none"> - Ensure that the LAN cable has good connection and is secured. - Refresh the browser and ensure that video is updated. - Cycle the camera's power off and on.
Video is noisy or distorted.	<ul style="list-style-type: none"> - Check the integrity of all connectors and splices of the Ethernet cable. <p>If O.K., then:</p> <ul style="list-style-type: none"> - Contact Bosch Technical Support.
Camera moves when attempting to move other cameras.	<ul style="list-style-type: none"> - Check that the camera’s IP address is properly set. <p>If camera’s IP address is not set, then:</p> <ul style="list-style-type: none"> - Use Configuration Manager to confirm that two cameras do not have the same IP address. If they do, change the address of one of the cameras.
No network connection.	<ul style="list-style-type: none"> - Check all network connections. - Ensure that the maximum distance between any two Ethernet connections is 100 m (328 ft) or less.

Problem	Questions to Ask/Actions to Resolve the Problem
	If O.K., then: - If you are behind a firewall, ensure that the Video Transmission mode is set to UDP.
Camera reboots frequently or intermittently.	Test your camera with another power supply. Check the Bosch website for a software update that might address the issue.
No OSD messages appear.	Bosch's Video SDK is required. Video management software from third parties does not use the SDK.
The image on the screen is dim.	Is the bubble dirty? If so, clean the bubble with a soft, clean cloth.
The contrast on the screen is too weak.	Adjust the contrast feature of the monitor. Is the camera exposed to strong light? If so, reposition the camera.
The image on the screen flickers.	Does the camera face directly into the sun or fluorescent lighting? If so, reposition the camera.
No video.	<ul style="list-style-type: none"> - Check that the mains power to the power supply is on. - Check to see if you have a web page. If you do, then try cycling the camera's power off and on. If you do not, then you may have the wrong IP address. Use Configuration Manager to identify the correct IP address. If O.K., then: <ul style="list-style-type: none"> - Check that there is 24 V output from the transformer. If O.K., then: <ul style="list-style-type: none"> - Check the integrity of all wires and mating connectors to the camera.
Picture is dark.	<ul style="list-style-type: none"> - Check that the Gain Control is set to High. If O.K., then: <ul style="list-style-type: none"> - Check that the Auto Iris Level is set to the appropriate level. If O.K., then: <p>Ensure that the maximum distance between any two Ethernet connections is 100 m (328 ft) or less.</p> If O.K., then: <ul style="list-style-type: none"> - Restore all camera settings.
Background is too bright to see subject.	Turn on backlight compensation.
Configuration or video management software identifies the unit as "Videojet Generic".	The model ID may be corrupt. Complete the steps in the section <i>Rebooting the unit</i> , page 63.

12.1

Rebooting the unit

Reboot the unit

After a Factory Default or firmware update, reboot the unit if:

- You cannot connect to the unit in the Web browser.

OR

- Configuration Manager or BVMS or similar software identifies the unit as “Videojet Generic”.
 - ▶ Reboot the unit using one of the following methods:
- In the web browser, type the IP address and then */reset* (without any punctuation). Press the **Enter** key.

OR

- In Configuration Manager, right-click the IP address and click **Restart**.
 - ▶ Wait two minutes for the process to complete.

If you cannot control the unit after the firmware upgrade, then cycle the power to the unit. If a power reset does not solve the problem, or if Configuration or video management software identifies the unit as “Videojet Generic,” then contact your Bosch Service Center for an RMA for the unit.

12.2 Physical reset button

You may need to complete a hardware reset if you have the following issues:

- You can power up the camera but cannot log on to the camera using the web browser.
- The camera does not start up, or fails to power up via PoE.
- The camera cannot search an IP address.
- The camera’s firmware crashed.
- You forgot the password to access the camera.
- The image becomes frozen.
- You cannot update the firmware.
- The camera disconnects from the network at random and needs a reboot.
- The camera no longer finds pre-positions (preset positions).
- You cannot configure the camera using the web browser.
- The camera has no video out.

Steps to complete a hardware reset for the camera

1. Apply power to the camera. Search for the IP address, and then log on to the camera using the web browser. (**Note:** You can use Configuration Manager to identify the IP address.)
2. Find the hardware reset button on the camera block. (See each section below to locate the reset button for your camera model.)
3. Push and hold the reset button for more than 8 seconds. The red LED indicator on the PCBA board will come on to show that the hardware reset started.
4. Let the camera complete a self-check. When the self-check completes, the red LED will go off.
5. Search again for the IP address. Access the camera using the web browser. Set the initial password for the camera.

For AUTODOME IP 5000i | AUTODOME IP starlight 5000i | AUTODOME IP starlight 5100i models, the reset button is near the SD card slot. To access the reset button, remove the camera bubble and turn the camera block upside down.



1	Reset button	2	SD card slot
---	--------------	---	--------------

12.3 Customer Service and Support

If this unit needs service, contact the nearest Bosch Security Systems Service Center for authorization to return and shipping instructions.

USA and Canada

Telephone: 800-289-0096, option 5

Fax: 800-366-1329

Email: repair@us.bosch.com

Customer Service

Telephone: 800-289-0096, option 3

Fax: 800-315-0470

Email: orders@us.bosch.com

Technical Support

Telephone: 800-289-0096, option 4

Fax: 800-315-0470

Email: technical.support@us.bosch.com

Europe, Middle East, Africa, and Asia Pacific Regions

Contact your local distributor or Bosch sales office. Use this link: <https://www.boschsecurity.com/xc/en/where-to-buy/>

13 Decommissioning

13.1 Transfer

The device should only be passed on together with this Installation manual.

13.2 Disposal



Disposal - Your Bosch product was developed and manufactured with high-quality material and components that can be recycled and reused. This symbol means that electronic and electrical appliances, which have reached the end of their working life, must be collected and disposed of separately from household waste material. Separate collecting systems are usually in place for disused electronic and electrical products. Please dispose of these units at an environmentally compatible recycling facility, per *European Directive 2012/19/EU*.

14

Support



Support

Access our **support services** at www.boschsecurity.com/xc/en/support/.

Bosch Security and Safety Systems offers support in these areas:

- [Apps & Tools](#)
- [Building Information Modeling](#)
- [Commissioning](#)
- [Warranty](#)
- [Troubleshooting](#)
- [Repair & Exchange](#)
- [Product Security](#)



Bosch Building Technologies Academy

Visit the Bosch Building Technologies Academy website and have access to **training courses**, **video tutorials** and **documents**: www.boschsecurity.com/xc/en/support/training/

Bosch Security Systems B.V.

Torenallee 49

5617 BA Eindhoven

Netherlands

www.boschsecurity.com

© Bosch Security Systems B.V., 2023

Building solutions for a better life.

202301192153